

Doe het zelf buitenverblijf

		D.H.Z. Buitenverblijf 700 x 310 cm	
		Woodvision B.V.	
Art. nr.:	Datum:	gewijzigd:	Pagina nr.
711404	7-7-2017	17-04-2020	01 van 18

Hoekpaal

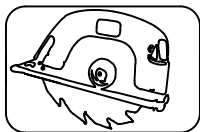
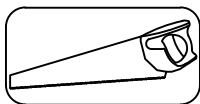
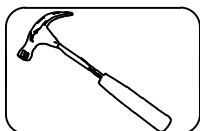
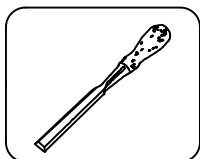
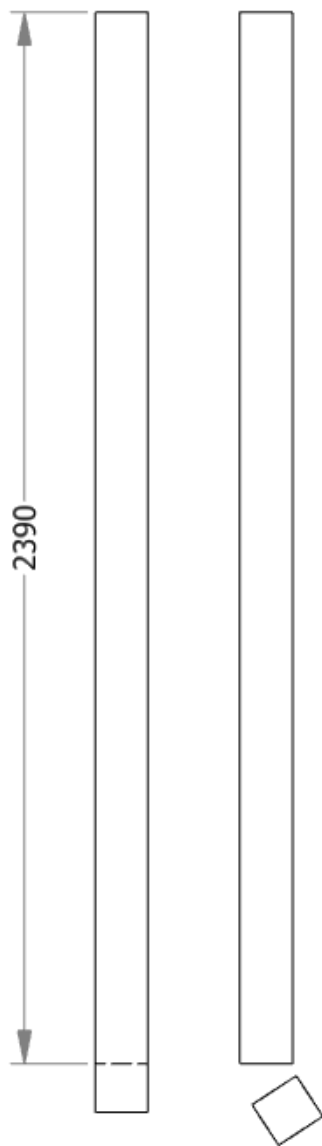

1a 4x

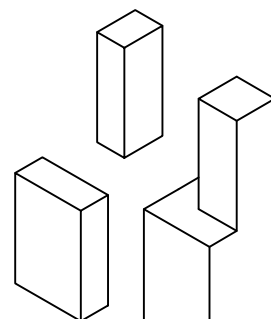
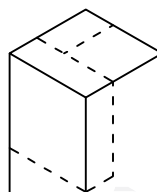

		D.H.Z. Buitenverblijf 700 x 310 cm	
		Woodvision B.V.	
Art. nr.:	Datum:	gewijzigd:	Pagina nr.
711404	7-7-2017	17-04-2020	04 van 18

Tussenpaal

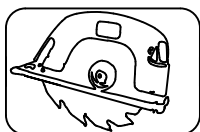
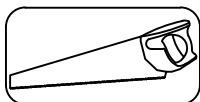
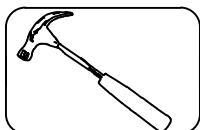
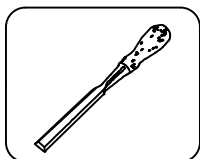
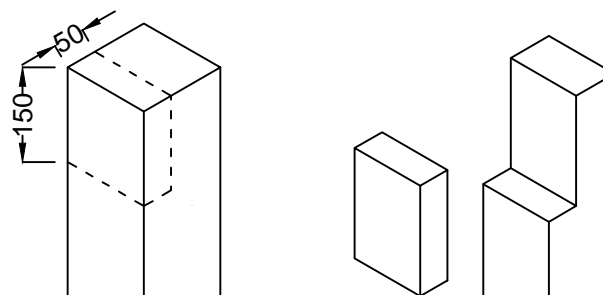
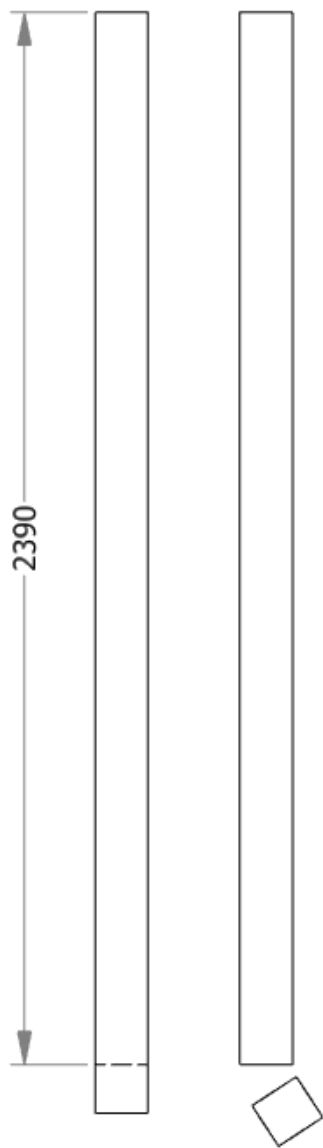

1b

2x

		D.H.Z. Buitenverblijf 700 x 310 cm	
		Woodvision B.V.	
Art. nr.:	Datum:	gewijzigd:	Pagina nr.
711404	7-7-2017	17-04-2020	05 van 18

Plattegrond

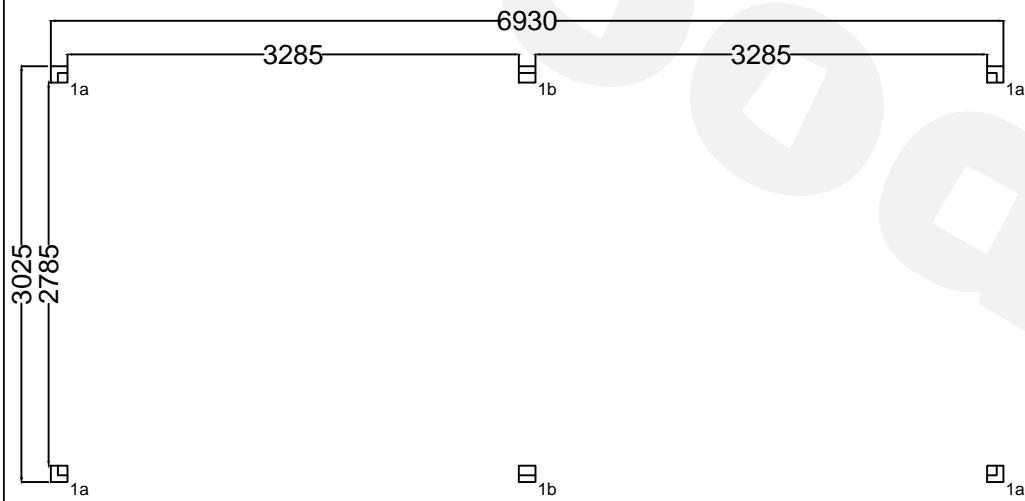

Zijaanzicht

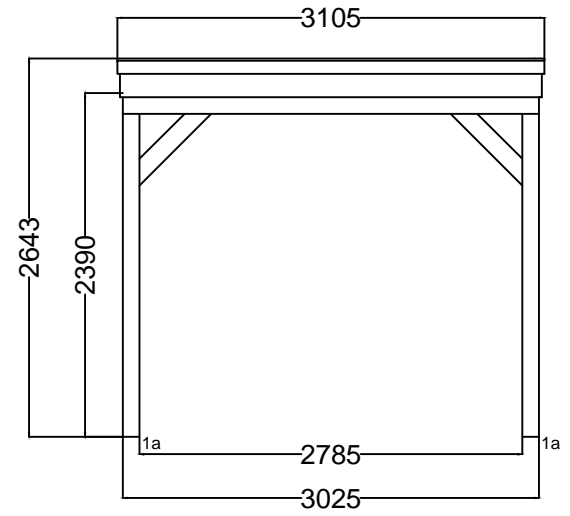

Vooraanzicht

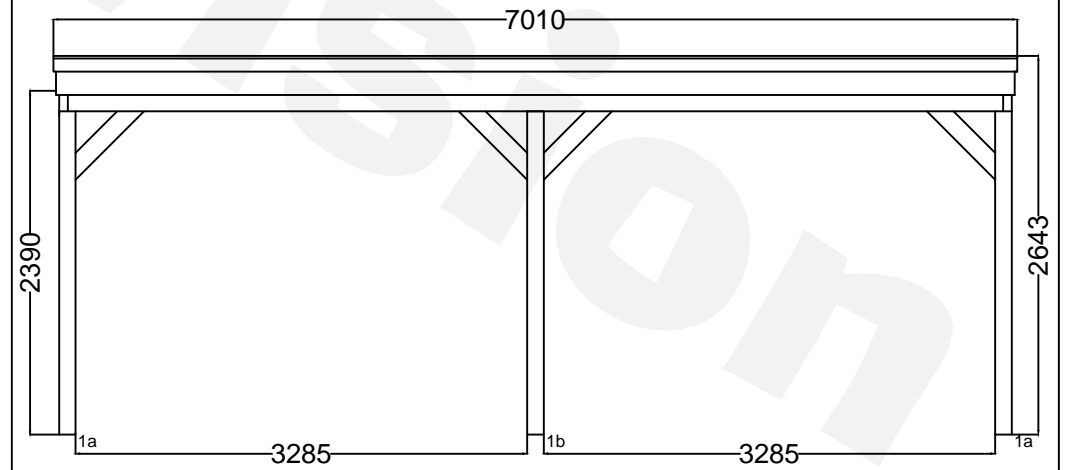

Montage betonpoer bij staanders

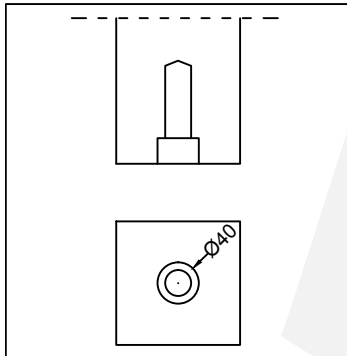

19066 montage verzinkte plaat + draadeind t.b.v. poer

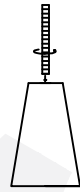

Monteer het draadeind in de betonpoer.

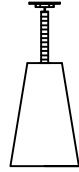

Monteer de plaat op het draadeind.



Plaats de staander op de plaat. Schroef vervolgens de plaat op de onderkant van de staander.



Bepaal de juiste hoogte door de balk te draaien.

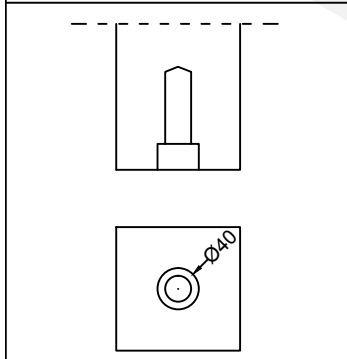

19043 Montage verstelbare pergola-steun



Monteer het draadeind in de betonpoer.



Monteer de moer en de plaat op het draadeind.

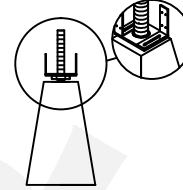

Verstelbare hoekbeugels bevestigen op de onderplaat met de slotbouten.

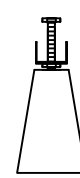

Tweede moer bevestigen. Draai de tweede moer niet vast i.v.m. verstelmogelijkheid. Laat de moer boven het draadeinde zitten



Plaats de staander op de plaat en schroef deze vervolgens vast.



Bepaal de juiste hoogte door aan de onderste moer te draaien.

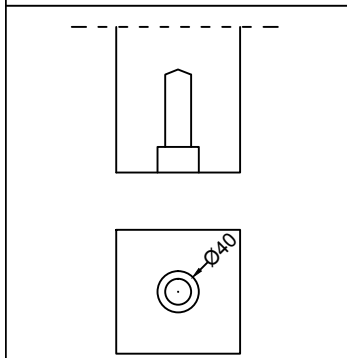

19065 Montage verzinkte plaat + draadeind t.b.v. pergola-steun

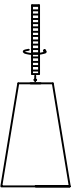

Monteer het draadeind in de betonpoer.

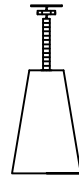

Monteer de moer en de plaat op het draadeind.



Tweede moer bevestigen.



Draai de tweede moer niet vast i.v.m. verstelmogelijkheid. Laat de moer boven het draadeinde zitten

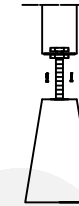

Plaats de staander op de plaat. Schroef vervolgens de plaat op de onderkant van de staander.

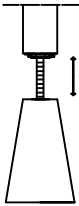

Bepaal de juiste hoogte door aan de onderste moer te draaien

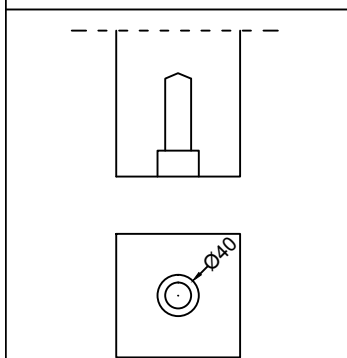

Aanstorten betonpoer

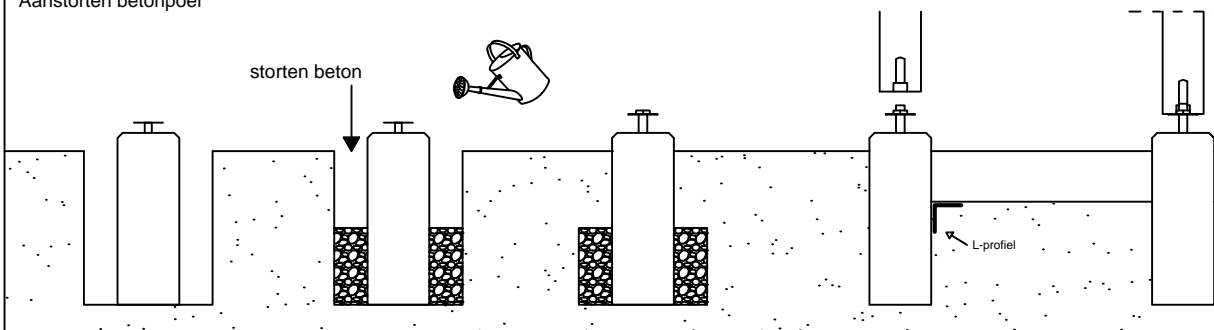

		D.H.Z. Buitenverblijf 700 x 310 cm	
		Woodvision B.V.	
Art. nr.: 711404	Datum: 7-7-2017	gewijzigd: 21-12-2017	Pagina nr. 07 van 18

Plaats de palen met de juiste afstand er tussen. Zet deze vast met schoren. Hiervoor kunt u het dakhout gebruiken (Piket niet inbegrepen).

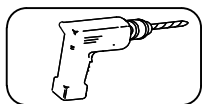
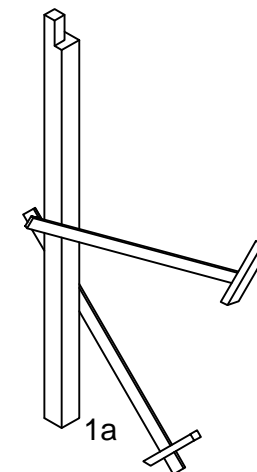
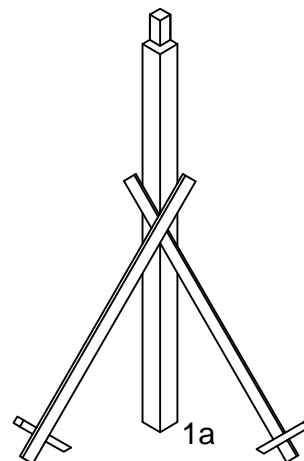
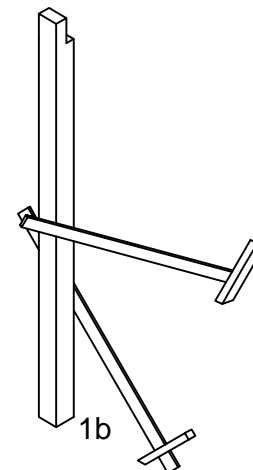
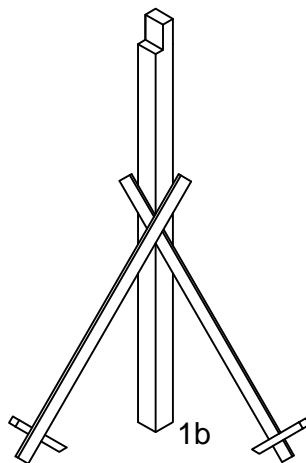
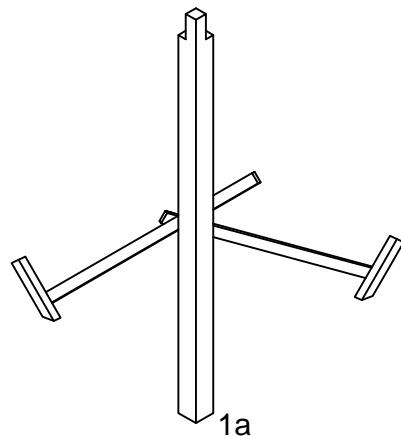
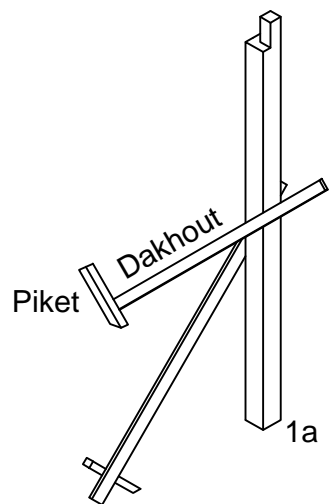

1a 4x

1b 2x

		D.H.Z. Buitenverblijf 700 x 310 cm	
		Woodvision B.V.	
Art. nr.:	Datum:	gewijzigd:	Pagina nr.
711404	7-7-2017	21-12-2017	08 van 18

Monteer de ringbalken

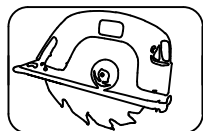
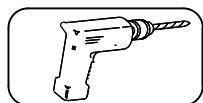
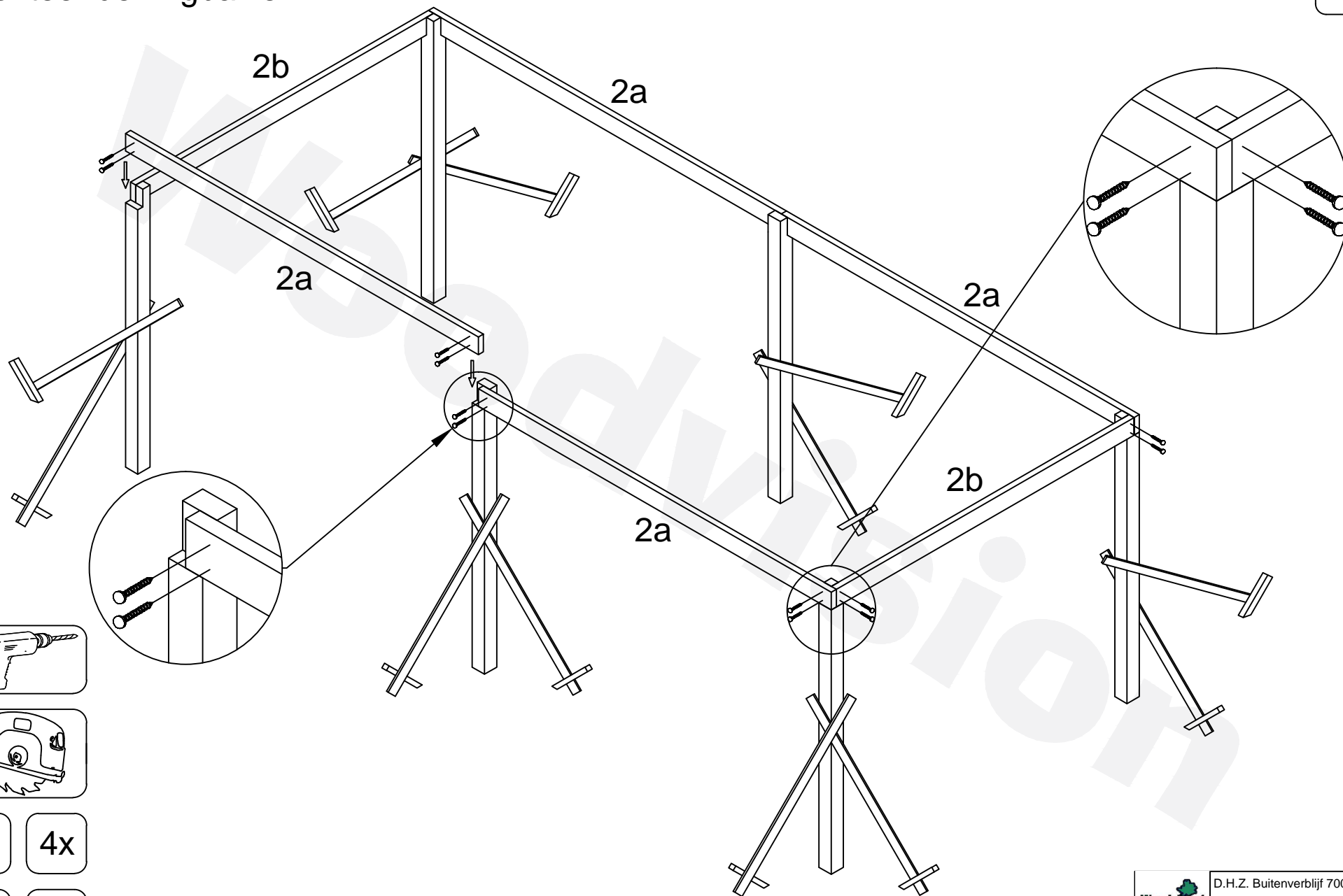
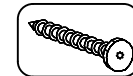

2a 4x

2b 2x



D.H.Z. Buitenverblijf 700 x 310 cm

Woodvision B.V.

Art. nr.:	Datum:	gewijzigd:	Pagina nr.
711404	7-7-2017	21-12-2017	09 van 18

Montage van de gording:

De achterzijde van de gording gelijk houden met de achterkant van de ringbalk. Controleer of de gordingen aan de voorkant op 1 lijn liggen.

Schroef nu de gordingen vast zoals is aangegeven in het montage detail.

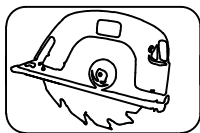
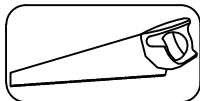
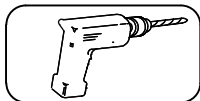
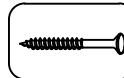

3

11x

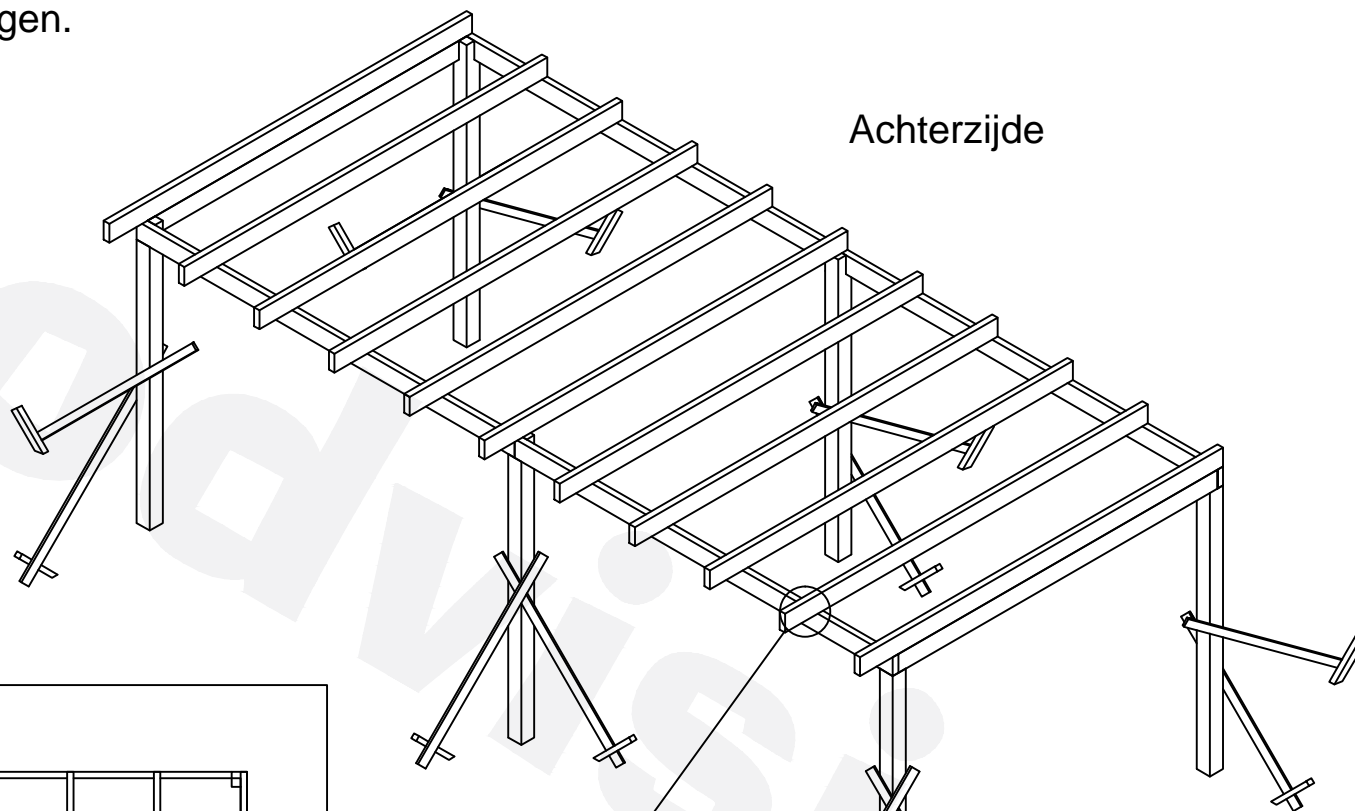
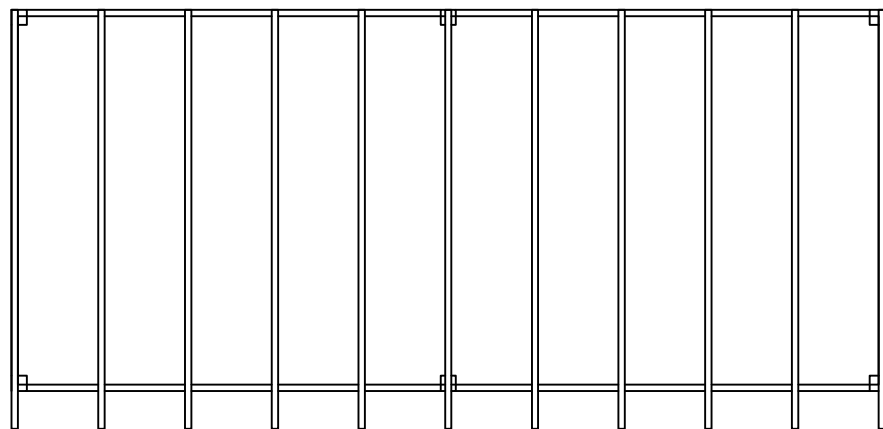

Achterzijde

Montage doorsnede



D.H.Z. Buitenverblijf 700 x 310 cm

Woodvision B.V.

Art. nr.:	Datum:	gewijzigd:	Pagina nr.:
711404	7-7-2017	21-12-2017	10 van 18

Monteer aan de voorzijde,
planken tussen de
gordingen. Schroef deze
vast zoals in het detail
staat aangegeven.

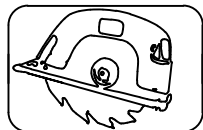
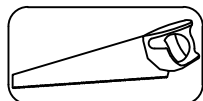
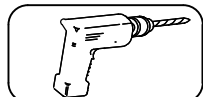
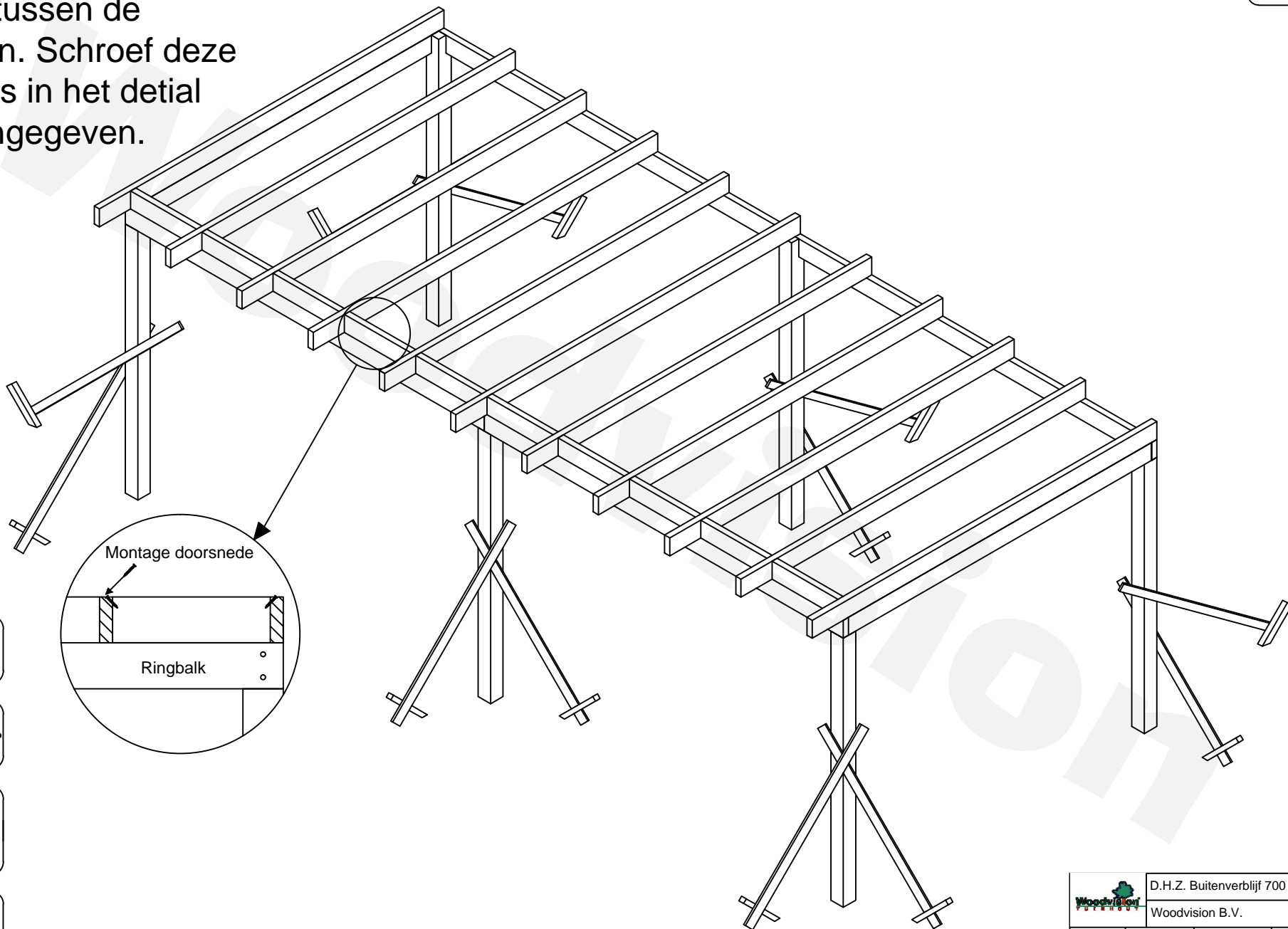
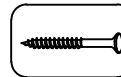

4

10x



D.H.Z. Buitenverblijf 700 x 310 cm

Woodvision B.V.

Art. nr.:
711404

Datum:
7-7-2017

gewijzigd:
21-12-2017

Pagina nr.
11 van 18

Monteer de schoren met 2 schroeven, zoals in het detail staat aangegeven.

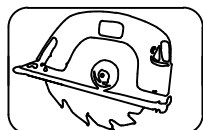
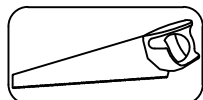
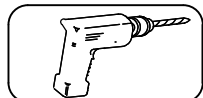
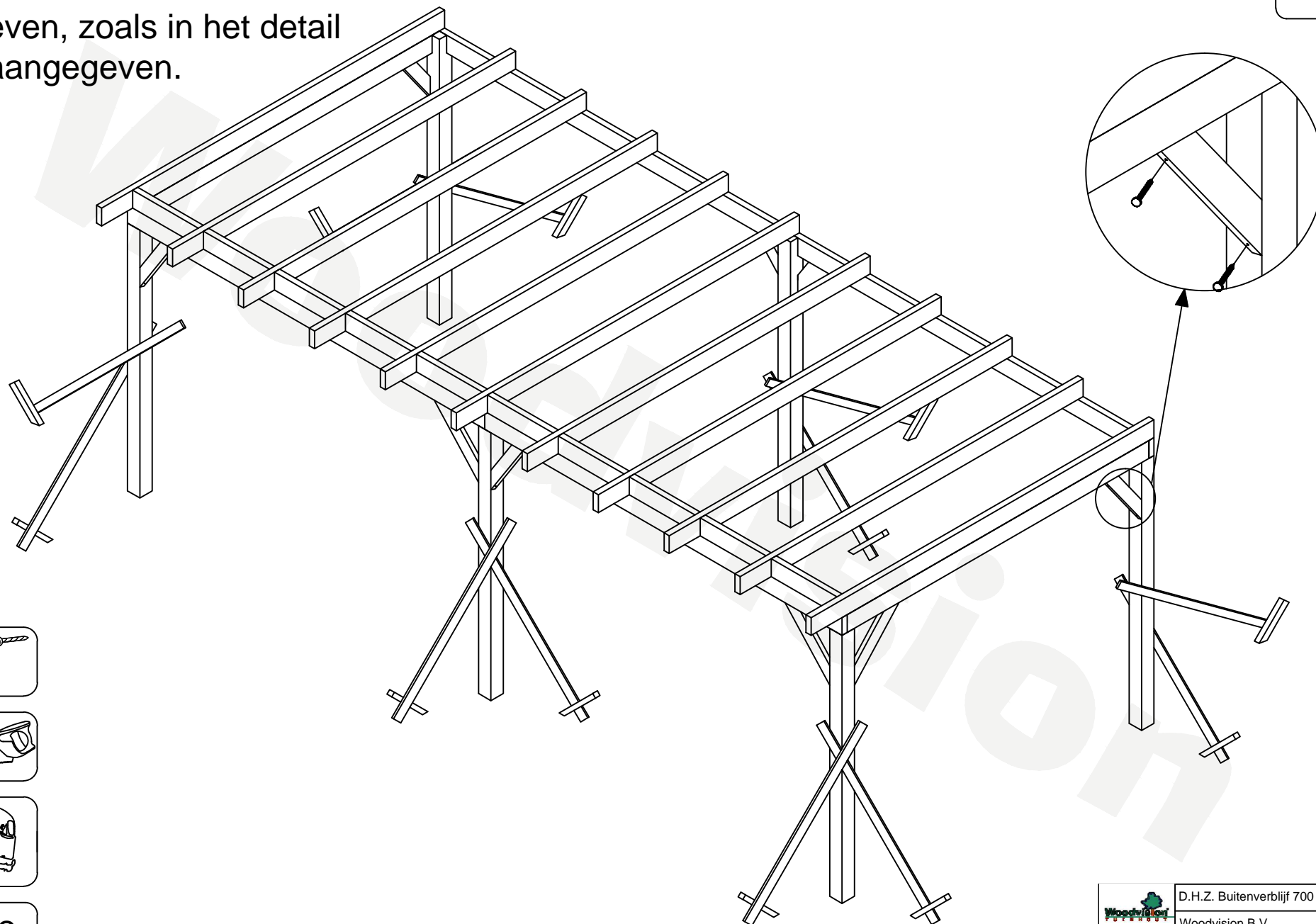
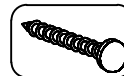

5

12x



D.H.Z. Buitenverblijf 700 x 310 cm

Woodvision B.V.

Art. nr.:	Datum:	gewijzigd:	Pagina nr.
711404	7-7-2017	21-12-2017	12 van 18

Monteer de boeiplank. Zorg dat de boeiplank 20 mm hoger ligt dan de bovenkant van de gording (zie detail). Zet de schroeven vast in de kopse kant van de gording. Met in elke gording 2 schroeven.

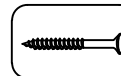

6b

6a

Bovenaanzicht

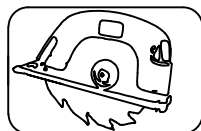
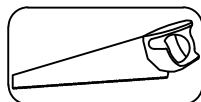
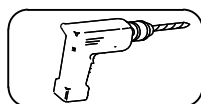
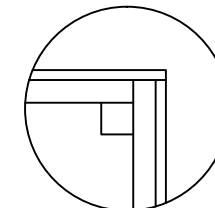
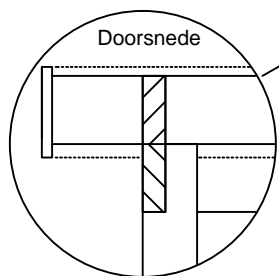

6a

4x

6b

2x

Wij raden u aan bij het monteren voor te boren.

Verwijder de hulpschoren.
Plaats het dakhout en monteer
deze op de gordingen met 2
spijkers per gording.



Begin hier met een hele plank

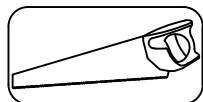
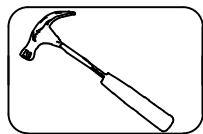
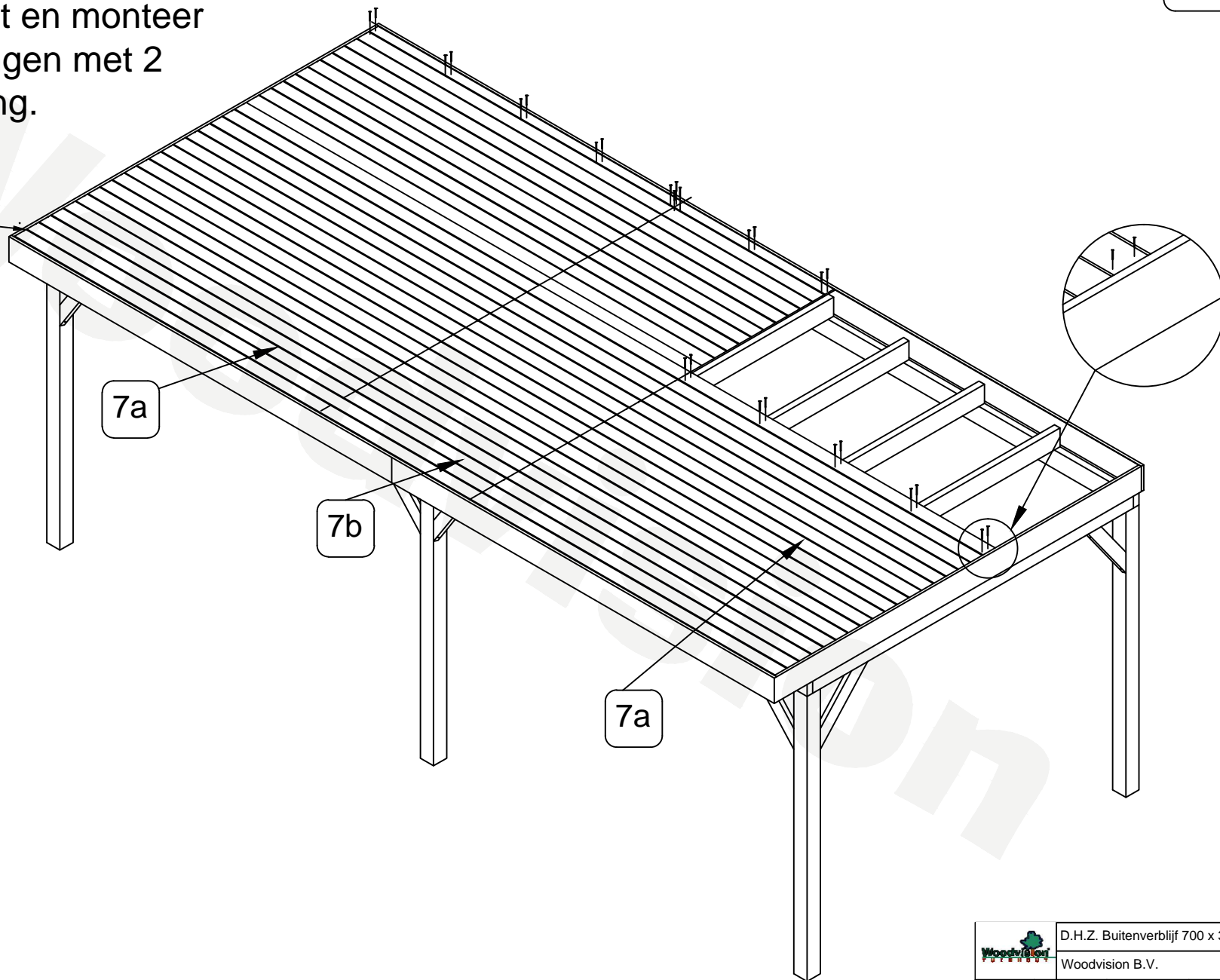

7a

68x

7b

34x



D.H.Z. Buitenverblijf 700 x 310 cm

Woodvision B.V.

Art. nr.:	Datum:	gewijzigd:	Pagina nr.
711404	7-7-2017	21-12-2017	14 van 18

Monteer de dakrand

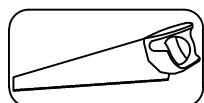
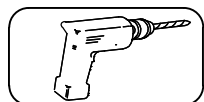
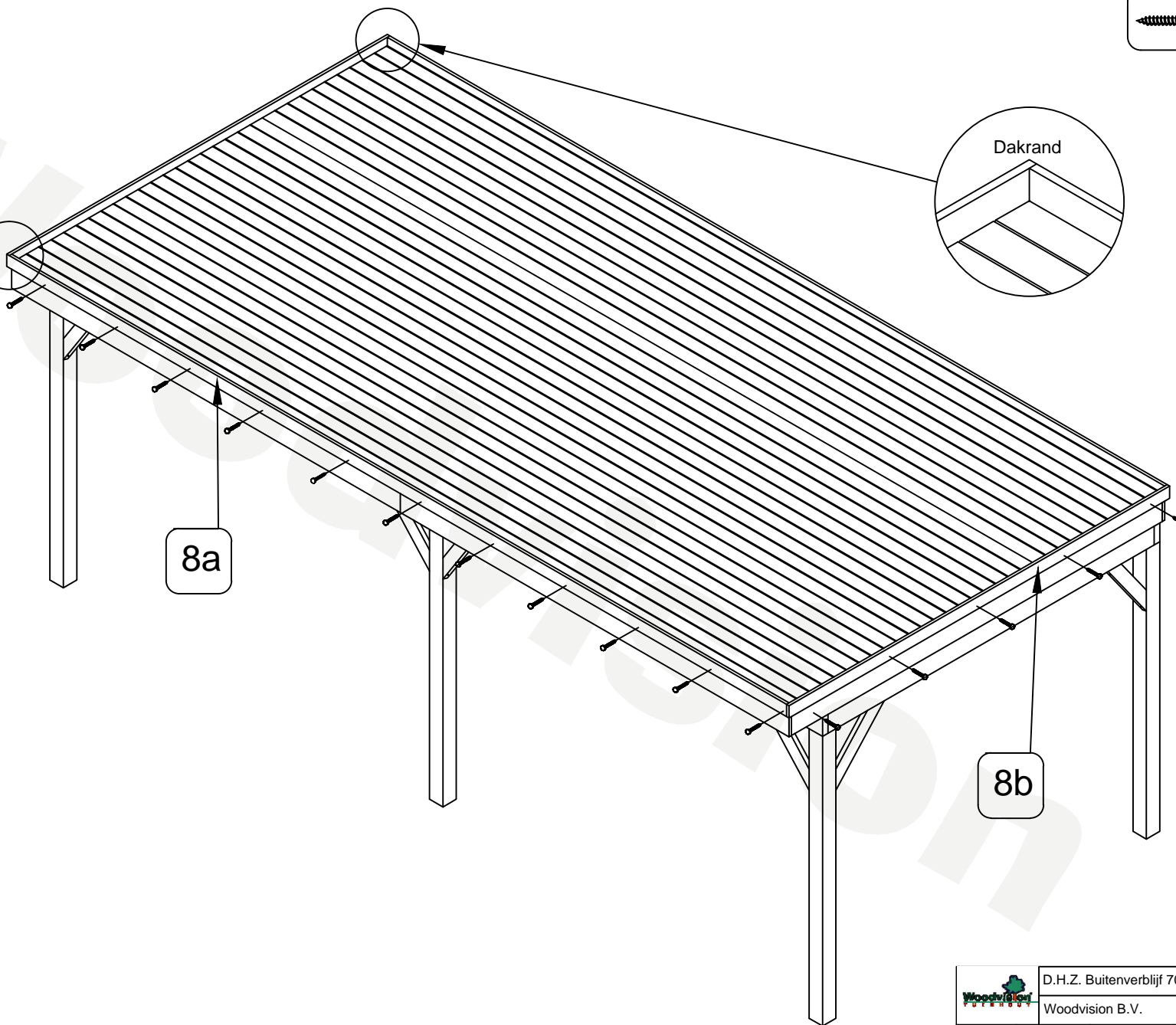
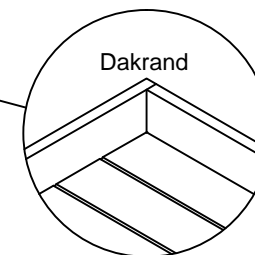
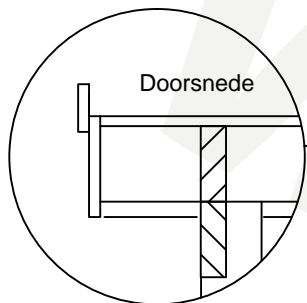
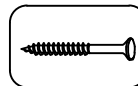

8a

4x

8b

2x



D.H.Z. Buitenverblijf 700 x 310 cm

Woodvision B.V.

Art. nr.:
711404

Datum:
7-7-2017

gewijzigd:
21-12-2017

Pagina nr.
15 van 18

Monteer het EPDM, zoals het op de beschrijving van het EPDM staat aangegeven.

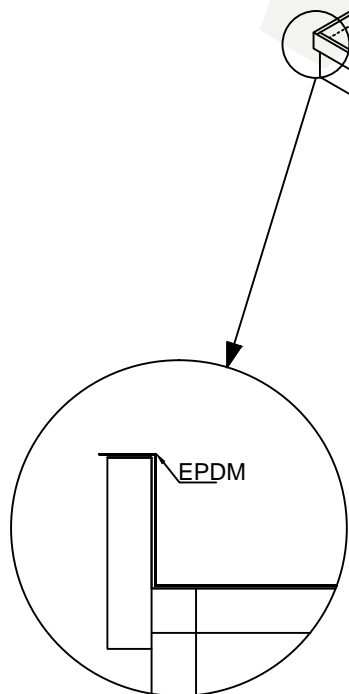

Vooraanzicht

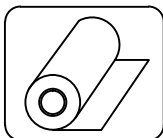

		D.H.Z. Buitenverblijf 700 x 310 cm	
		Woodvision B.V.	
Art. nr.:	Datum:	gewijzigd:	Pagina nr.
711404	7-7-2017	21-12-2017	16 van 18

Plaats de afdeklIJst bovenop de boeiplank

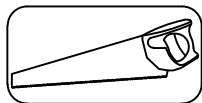
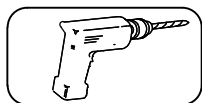
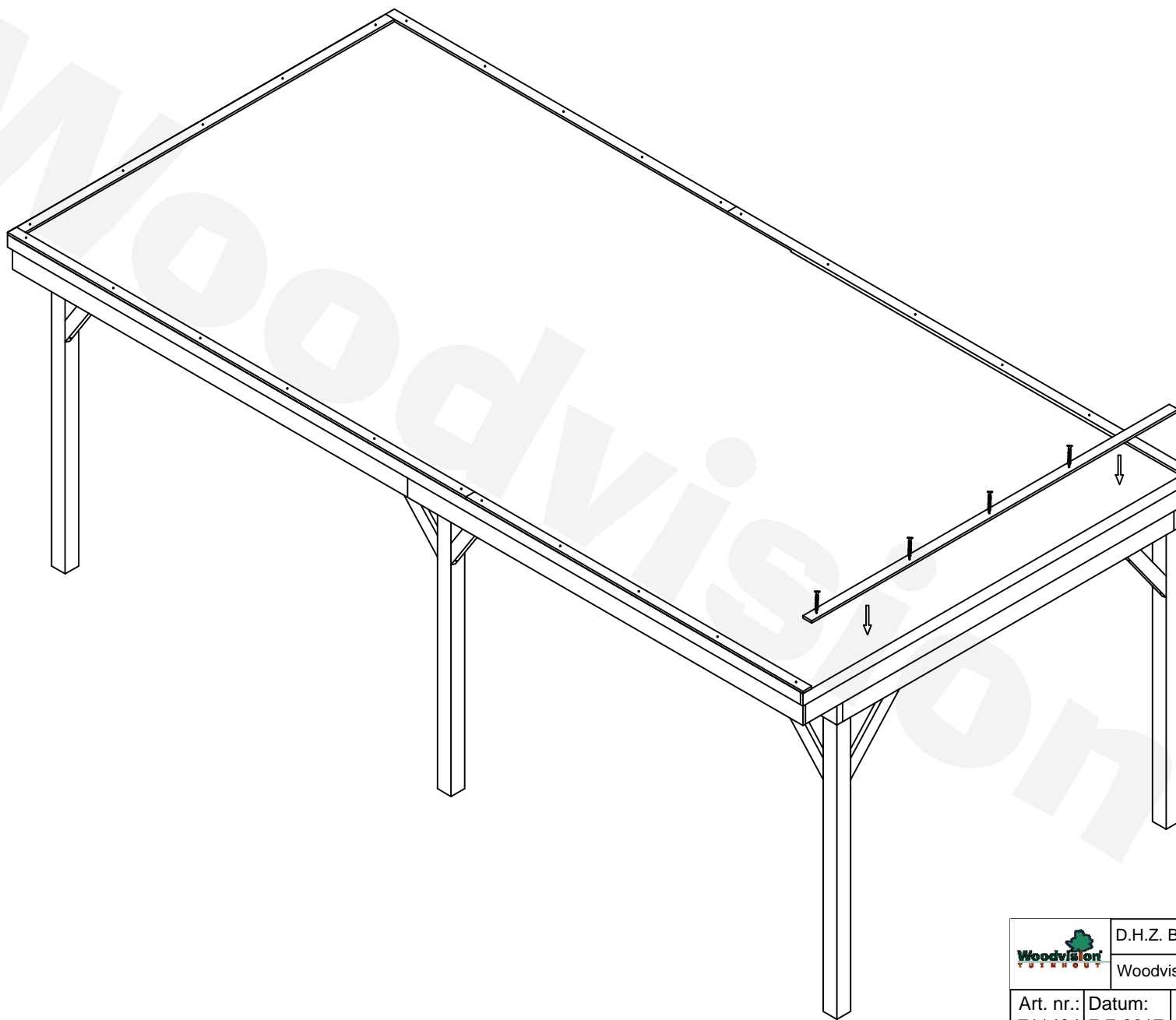
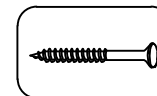



9

6x

	D.H.Z. Buitenverblijf 700 x 310 cm		
	Woodvision B.V.		
Art. nr.: 711404	Datum: 7-7-2017	Datum: 21-12-2017	Pagina nr. 17 van 18

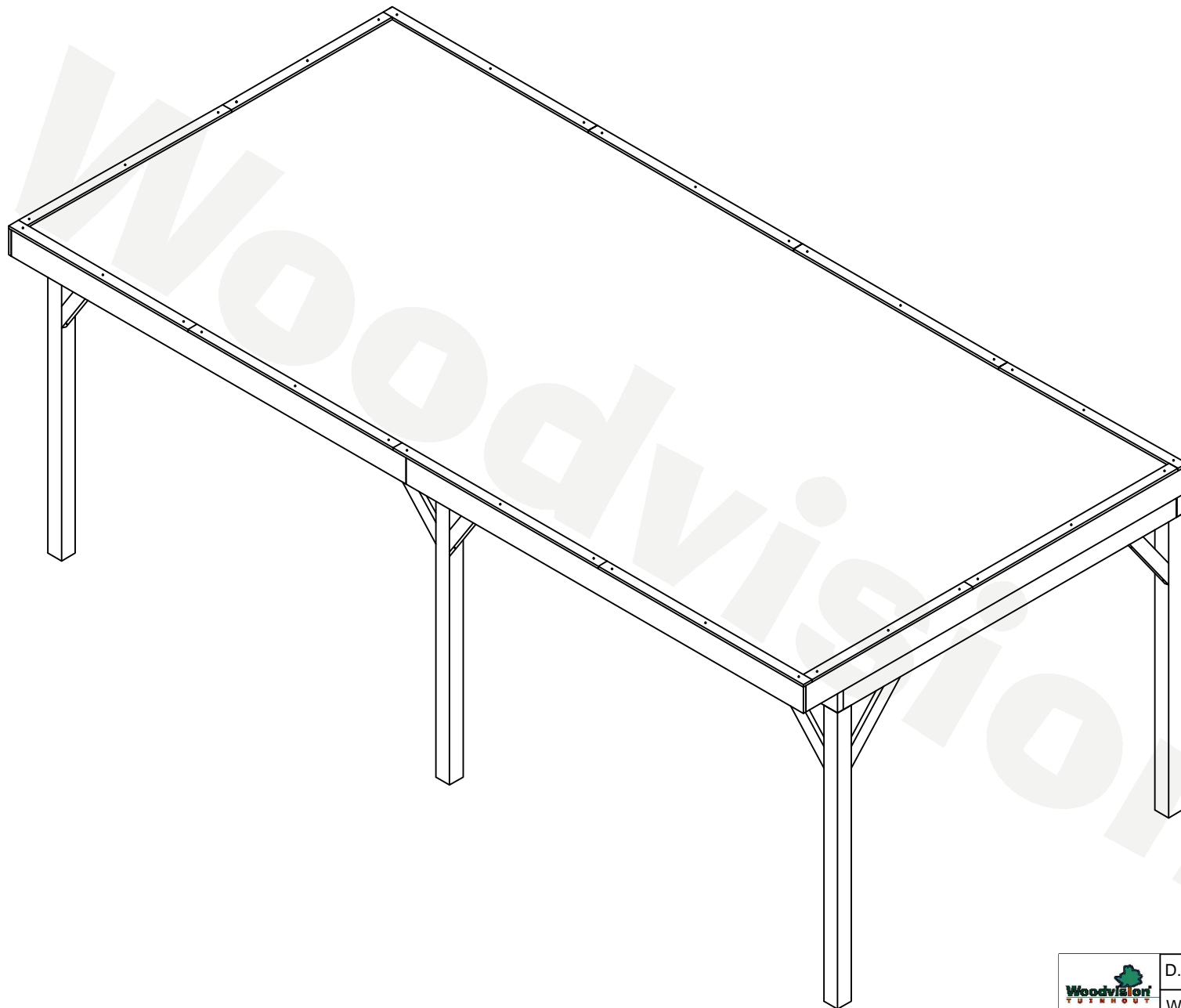
Eindresultaat



	D.H.Z. Buitenverblijf 700 x 310 cm		
	Woodvision B.V.		
Art. nr.: 711404	Datum: 7-7-2017	Datum: 21-12-2017	Pagina nr. 18 van 18