

Design Guide

STEICO *LVL* / Laminated Veneer Lumber

Construction elements –
made naturally out of wood

Technical detailing

Contents

Overview	S. 02
Sole and top plates	S. 06
Wall studs	S. 08
Lintels	S. 13
Rimboards	S. 16
Ceilings	S. 18
Roof and floor slabs	S. 21
Roof overhangs	S. 23
Mechanical properties	S. 26
Calculation software	S. 28
Fasteners	S. 29
Other properties	S. 30
General Information	S. 31
Delivery options	S. 32



**STEICO**
engineered by nature



STEICO *LVL* / Laminated Veneer Lumber

Dimensional stability, high strength and load bearing capacity

STEICO *LVL* is one of the most stable engineered wood products. It consists of several layers of approx. 3 mm thick, glued softwood veneers (spruce/pine). Defects are evenly distributed resulting in a nearly uniform cross section. This structure gives STEICO *LVL* maximum strength.

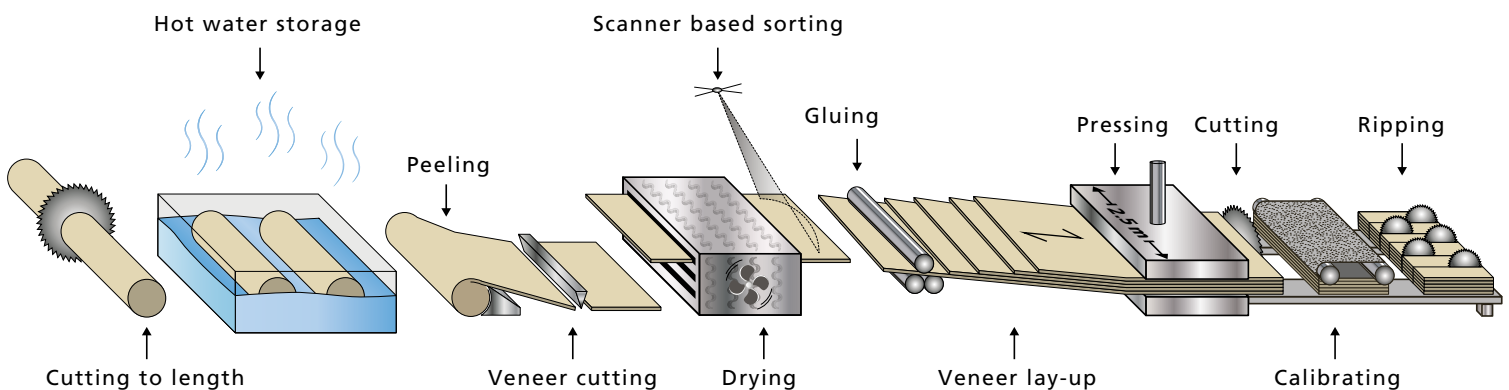

DRY

No drying shrinkage because STEICO *LVL* is made with a moisture content of approx. 9% (corresponds to in-use equilibrium moisture).

SORTED

A high-performance material from automated testing and strength grading of every single veneer.

HOMOGENEOUS

Uniform strength throughout, since defects like knots are limited to a single sheet of veneer.

GLUED

Dimensional stability due to waterproof bonding – no twisting, no shrinkage, absolutely straight components.

DENSIFIED

Higher strength compared to softwood due to densification during pressing.

VERSATILE

Large-format production allows the cutting of all sizes, sticks and panels.

STEICO LVL R

Laminated Veneer Lumber

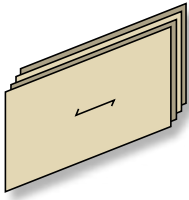

STEICO LVL R components consist of veneers that are all bonded in longitudinal layer orientation. Powerful wood material for beam and stud applications.

APPLICATIONS

- Floor joists
 - Rafters
 - Main beams
 - Studs
 - Sole and top plate
 - Lintels
 - Beam reinforcements
- and many more

STEICO LVL X

Laminated Veneer Lumber with cross-layers

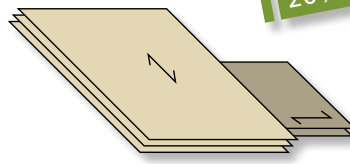

20% Cross-Layers

STEICO LVL X components consist of veneers where approximately one-fifth are bonded in cross-orientation increasing the load-carrying capacity when used as panels as well as the dimensional stability and rigidity.

APPLICATIONS

- Rimboards
 - Load-bearing walls
 - Roofs and ceilings
 - Trusses
 - Roof overhangs
 - Curved components
- and many more



Allgemeine bauaufsichtliche Zulassung Z-9.1-842



The product for highest requirements in timber construction

Easy to handle and easy to design

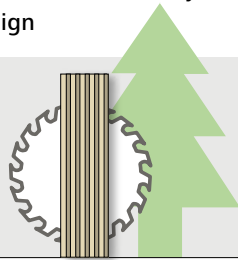

STEICO LVL consists of softwood veneer and is easy to process - pre-drilling of fasteners is not necessary. The design is carried out according to EC 5 / AbZ Z-9.1-842. The design software Xpress is available at STEICO.

Dimensional stable

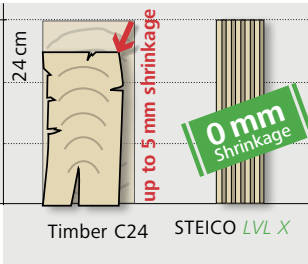

STEICO LVL X has the smallest swelling and shrinkage under the common engineered wood products. Drying shrinkage is avoided thank to the production moisture content of approx. 9%.

High strength

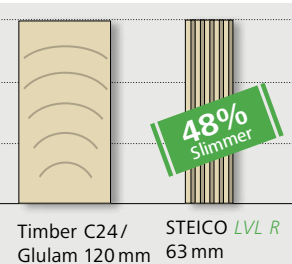

High-strength cross sections allow for slender structures - or significantly stronger structures when compared to the same cross sections out of solid wood.

Extremely resistant

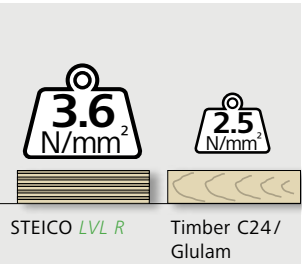

Extreme resistance where it matters most such as sole and top plates. Not only is material and weight reduced, but also compression settlements are avoided.

Characteristic strength and stiffness properties (N/mm²) for STEICO LVL for design according to EC 5

The characteristic density of STEICO LVL R and STEICO LVL X is 480 kg/m ³ .	STEICO LVL R		STEICO LVL X*	
	Flatwise loading	Edgewise loading	Flatwise loading	Edgewise loading
Bending II to the grain $f_{m,0,k}$ / \perp to the grain $f_{m,90,k}$	50.0 / -	44.0 / -	36.0 / 8.0	32.0 / 8.0
Tension II to the grain $f_{t,0,k}$	36.0	36.0	18.0	18.0
Compression II to the grain $f_{c,0,k}$ / \perp to the grain $f_{c,90,k}$	40.0 / 3.6	40.0 / 7.5	30.0 / 4.0	30.0 / 9.0
Shear $f_{v,k}$	2.6	4.6	1.1	4.6
Modulus of elasticity II to the grain $E_{0,mean}$ / \perp to the grain $E_{90,mean}$	14,000 / -	14,000 / -	10,600 / 2,500	10,600 / 3,000

* Values for 27 mm ≤ t ≤ 75 mm. A complete overview of the values can be found on p. 26.

Up to 67% material saving

Due to the higher strength and stiffness properties of STEICO *LVL R* when compared to solid softwood products, significant material savings are obtained.

Equivalent cross-section widths:

- Smaller sections due to higher strength properties
- Lighter components thanks to material savings
- Easier handling thanks to reduced cross section widths (E.g. using smaller circular saws)

The following table shows the dimensions and material savings of STEICO *LVL* when compared to other building materials. As the basis for this comparison for beams with a constant height of 240 mm, solid wood of class C24 is used and compared to glulam GL 24c and STEICO *LVL R*. The width varies according to the material-saving potential.

	Solid Timber C24			Glulam GL 24c			STEICO <i>LVL R</i>		
	Property	Width	Material savings	Property	Width	Material savings	Property	Width	Material savings
Bending $f_{m,0,edge,k}$	24.0 N/mm ²	140 mm	0%	24.0 N/mm ²	128 mm*	9%	44.0 N/mm ²	74 mm*	47%
Shear $f_{v,0,edge,k}$	4.0 N/mm ²	140 mm	0%	3.5 N/mm ²	112 mm*	20%	4.6 N/mm ²	61 mm*	57%
Compression II $f_{c,0,k}$	21.0 N/mm ²	140 mm	0%	21.5 N/mm ²	137 mm	2%	40.0 N/mm ²	74 mm	48%
Compression \perp $f_{c,90,edge,k}$	2.5 N/mm ²	140 mm	0%	2.5 N/mm ²	140 mm	0%	7.5 N/mm ²	47 mm	67%
Tension II $f_{t,0,k}$	14.0 N/mm ²	140 mm	0%	17.0 N/mm ²	105 mm*	25%	36.0 N/mm ²	54 mm	61%
Elastic modulus $E_{0,mean}$	11,000 N/mm ²	140 mm	0%	11,000 N/mm ²	140 mm	0%	14,000 N/mm ²	110 mm	21%
Characteristic density app. ρ_k	350 kg/m ³	-	-	365 kg/m ³	-	-	480 kg/m ³	-	-

Boundary conditions

$k_{c,90} = 1.0$

* In considering of correction factors

STEICO LVL – Range of applications

Range of Applications



STEICO LVL is a high-strength versatile material. In the following, selected fields of application in housing construction are presented as well its advantages and detailed design guidance.

- A** Sole and top plates S. 06
- B** Wall studs S. 08
- C** Lintels S. 13
- D** Rimboard S. 16
- E** Ceilings S. 18
- F** Roof and floor slabs S. 21
- G** Roof overhangs S. 23

Future-oriented material in a trend-setting building system

The more demanding the requirements, the better its suitability – STEICO LVL is the high-performance material for innovative wood construction. Together with the other components of the STEICO product family (I-joists and natural insulating materials), a complete range for structural and insulating building envelope materials is available for wood construction – a complete house from one source. That's the STEICO Natural Building System.



Laminated Veneer Lumber: STEICO LVL

I-joists STEICOjoist and STEICOWall

Rigid and flexible wood-fiber insulation

Wood fiber and cellulose air injected insulation

Sealing system for the building shell

Sole and top plates: extreme resistance, prevention of settlements



Walls in wood frame construction can be optimized in many areas through the use of STEICO LVL as sole and top plates. Due to the high compressive strength perpendicular to the grain, stud cross-sections can be reduced in both exterior and interior walls and sole-plates can be extended beyond the edge of the concrete slab.

Advantages at a glance

Compressive strength perpendicular to the grain in-plane, flatwise applications **1**

- STEICO LVL R: $f_{c,90,flat,k} = 3.6 \text{ N/mm}^2$
- STEICO LVL X: $f_{c,90,flat,k} = 4.0 \text{ N/mm}^2$

Optimum utilization of wood / reducing wood consumption

- Reduced cross-sections of highly loaded studs, e.g. next to windows
- Increased useable living space through reduced indoor wall depth
- Optimal in combination with STEICO I-joists

Optimized socket detail **2**

- Possibility for extended walls
- Creation of drip edges
- Economic construction with thin render boards

Sole plates without the use of chemical wood protection

- Use class 0 (GK0) in accordance with DIN 68800-2 – no risk due to moisture or insect infestation, thus no chemical wood protection necessary
- Wood protection by design in accordance with DIN 68800-2 must be applied
- Use of STEICO LVL similar to solid softwood members

Reduction of sole plate height from 60 mm to 45 mm **3**

- Saving material
- Minimising heat bridges
- Reducing compression perpendicular to the grain settlements
- Two part shear anchors for soleplate heights from 45 mm, for example from Simpson Strong Tie®, are available.

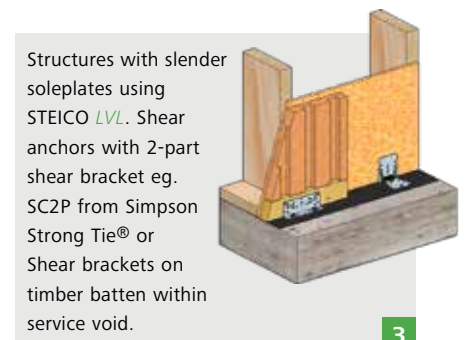
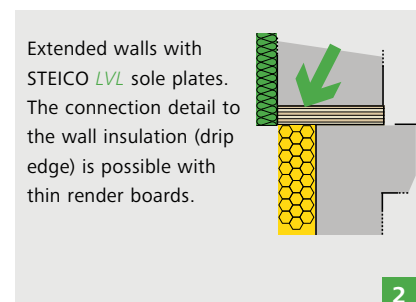
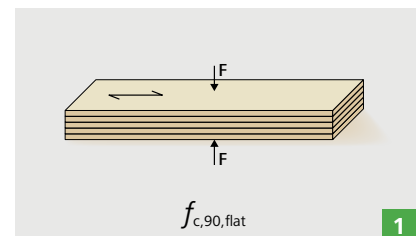

STEICO LVL as sole and top plates

Preliminary design of STEICO LVL R sole and top plates

The table contains the maximum loads for STEICO LVL R sole plates, considering the following boundary conditions:

- For load-bearing exterior walls, the detail can extend up a maximum of half the stud depths beyond the load-carrying floor below. Only the supported section is considered for the design check
- Studs in the end-section of the sole plate are to be checked separately
- Alternatively, STEICO LVL X can be used

Type	Stud depth h_{ST} [mm]	Characteristic resistance per post	
		Full support (Interior and exterior walls) 1	Half support (Exterior walls) 2
		STEICO LVL R R_k in [kN]	STEICO LVL R R_k in [kN]
STEICO LVL R Stud width $b_{ST} = 45$ mm	80	45.4	–
	100	56.7	–
	120	68.0	–
	200	113.4	56.7
	220	124.7	62.4
	240	136.1	68.0
	280	158.8	79.4
STEICO LVL R Stud width $b_{ST} = 57$ mm	80	50.5	–
	100	63.2	–
	120	75.8	–
	200	126.4	63.2
	220	139.0	69.5
	240	151.6	75.8
	280	176.9	88.5
STEICO LVL R Stud width $b_{ST} = 75$ mm	80	58.3	–
	100	72.9	–
	120	87.5	–
	200	145.8	72.9
	220	160.4	80.2
	240	175.0	87.5
	280	204.1	102.1
Solid timber Stud width $b_{ST} = 60$ mm	80	51.8	–
	100	64.8	–
	120	77.8	–
	200	129.6	64.8
	240	155.5	77.8
Solid timber Stud width $b_{ST} = 80$ mm	80	60.5	–
	100	75.6	–
	120	90.7	–
	200	151.2	75.6
	240	181.4	90.7

General notes

These tables are to be used for preliminary design and do not replace a static design check.

The design value of the compressive strength is calculated as: $N_d = \text{Table-value } (R_k) \cdot k_{mod} / \gamma_m$.

The characteristic values on page 26 are to be used for individual design checks.

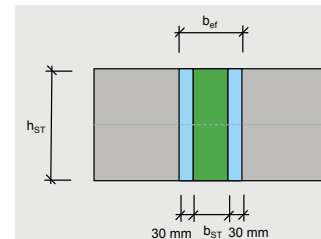
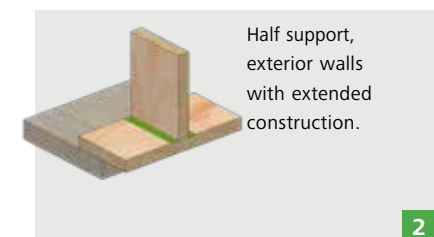
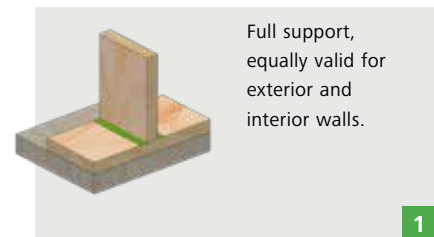

The bearing check is carried out with a $k_{c, 90}$ value of 1.25 as for solid wood. In addition, the increase factor for the service class 1 according to German approval AbZ Z-9.1-842 is set to 1.20.

Wall Studs: high-capacity, slims posts



Due to the high strength and stiffness of STEICO *LVL R*, the stud cross-sections for walls in wood frame construction can be reduced, respectively higher loads can be carried. Wall studs from STEICO *LVL R* are thus well suited for highly loaded components such as studs next to window openings or in load-bearing interior walls.

Advantages at a glance

Compressive strength parallel to the grain **1**

- STEICO *LVL R*: $f_{c,0,k} = 40.0 \text{ N/mm}^2$

High load-carrying capacity

- Ideal for heavily loaded studs such as next to window openings
- Even small stud cross-sections can carry high loads
- Straight product, thus improved imperfection reduction factor of $\beta_c = 0.1$ (measure of eccentricity)

Slender interior walls **2**

- Reduced wall depth, thus gains in usable space and increase of the real estate value

Technically refined product

- Dry, dimensionally stable, thus no risk of shrinkage cracks
- Form stable components, thus large wall depths possible
- Permanently straight, thus benefits during use

Other advantages of STEICO *LVL R* as a wall stud

- Reduced cross-sections for minimized thermal bridges
- Matched to the height of STEICO I-joists

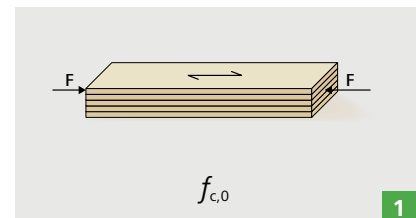

Reduction of buckling and lateral torsional buckling risk.

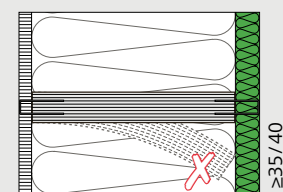

- Interior side: stabilisation through panels (OSB or gypsum board).
- Exterior side: stabilisation through STEICO*universal* or STEICO*protect H*.

Learn more about
bracing wood-fiber insulation at:
www.steico.com/aussteifung

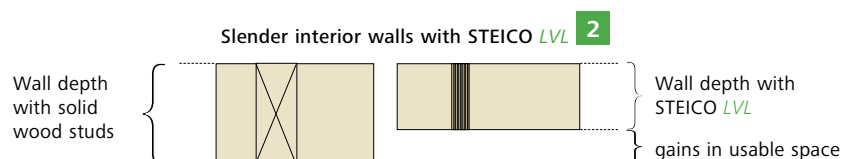

STEICO LVL R for wall studs

Preliminary design of STEICO LVL R as a wall stud

The table contains the maximum loads (axial pressure) for STEICO LVL R wall studs, considering the following boundary conditions:

- The table shows a full stud support for exterior or interior walls and a half support for extended exterior walls.
- Buckling: The loaded studs are supported in-plane of the wall, means the table values only consider bending (and buckling) about the strong axis of the stud (Euler buckling case 2 | $\beta = 1,0$ | $L_{ef} = h$).
- The design check for compression perpendicular to the grain can be done using the table on page 7.

Type	Stud depth	Characteristic resistance per stud			
		Full support (Interior and exterior walls) 1		Half support (Exterior walls) 2	
	h_{ST} [mm]	$H_{Wall}=3.0m$	$H_{Wall}=4.0m$	$H_{Wall}=3.0m$	$H_{Wall}=4.0m$
		R_k in [kN]		R_k in [kN]	
STEICO LVL R Stud width $b_{ST}=45$ mm	80	24.2	13.8	–	–
	100	46.6	26.7	–	–
	120	78.9	45.6	–	–
	200	289.2	196.2	144.6	98.1
	220	340.9	251.5	170.4	125.7
	240	387.5	309.7	193.8	154.9
	280	472.0	421.0	236.0	210.5
STEICO LVL R Stud width $b_{ST}=57$ mm	80	30.7	17.5	–	–
	100	59.0	33.8	–	–
	120	100.0	57.8	–	–
	200	366.3	248.5	183.2	124.2
	220	431.8	318.5	215.9	159.3
	240	490.9	392.3	245.4	196.2
	280	597.9	533.3	299.0	266.6
STEICO LVL R Stud width $b_{ST}=75$ mm	80	40.3	23.0	–	–
	100	77.6	44.5	–	–
	120	131.6	76.0	–	–
	200	482.0	327.0	241.0	163.5
	220	568.1	419.1	284.1	209.6
	240	645.9	516.2	322.9	258.1
	280	786.7	701.7	393.4	350.8
	300	853.3	784.3	426.7	392.2

General notes

These tables are to be used for preliminary design and do not replace a static design check. The design value of the normal strength is calculated as: $N_d = \text{table-value} (R_k) \cdot k_{mod} / \gamma_m$. The table considers a simply supported element (Euler buckling case 2). The characteristic values on page 26 are to be used for individual design checks.

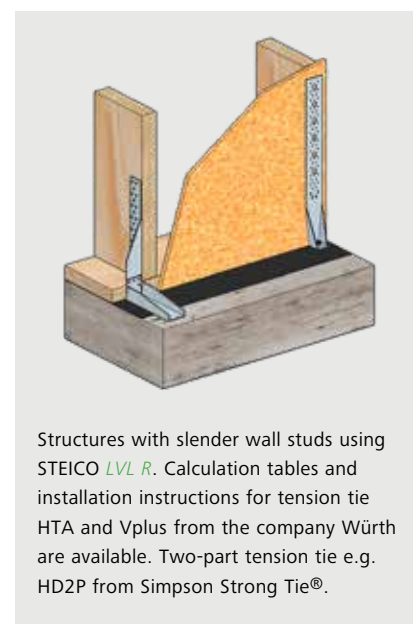

Structures with slender wall studs using STEICO LVL R. Calculation tables and installation instructions for tension tie HTA and Vplus from the company Würth are available. Two-part tension tie e.g. HD2P from Simpson Strong Tie®.

STEICO LVL R for wall studs

Design example wall stud

System

Wall height $H_{wall} = \dots\dots\dots 3.00\text{ m}$
 Support condition = Full support
 Stud width $b = \dots\dots\dots 45\text{ mm}$
 Stud depth $h = \dots\dots\dots 200\text{ mm}$

Loads

$F_{k, perm} = \dots\dots\dots 40.0\text{ kN}$
 $F_{k, med} = \dots\dots\dots 20.0\text{ kN}$

Design loads

$N_{d, med} = \gamma_G * N_{k, perm} + \gamma_Q * N_{k, med} =$
 $1.35 * 40.0 + 1.5 * 20.0 = 84.0\text{ kN}$

$N_{d, perm} = \gamma_G * N_{k, perm} =$
 $1.35 * 40.0 = 54.0\text{ kN}$

Design check

Bending (buckling) about the strong axis (y-axis):

$R_{k, y} = 289.2\text{ kN}$ (see table on page 9)

$$\eta_{med} = \frac{N_{d, med}}{R_{k, y} * k_{mod, med}} = \frac{84.0}{289.2 * 0.8} = 0.47 \leq 1.0$$

$$\eta_{perm} = \frac{N_{d, perm}}{R_{k, y} * k_{mod, const}} = \frac{54.0}{289.2 * 0.6} = 0.40 \leq 1.0$$

For wind load on the exterior wall, the design check according to clause 6.3.2 of EN 1995-1-1 (equation 6.23) has to be done.

Buckling coefficients k_c for STEICO LVL R

For the simplified design check of STEICO LVL R stud cross-sections, the buckling coefficients k_c are tabulated as a function of slenderness λ . The buckling check has to be according to clause 6.3.2 of EN 1995-1-1

Buckling coefficients k_c for STEICO LVL R according to EN1995-1-1: 2010-12 clause 6.3.2

slenderness	Buckling coefficient	slenderness	Buckling coefficient	slenderness	Buckling coefficient
λ	k_c	λ	k_c	λ	k_c
[-]	[-]	[-]	[-]	[-]	[-]
10	1.000	105	0.254	200	0.072
15	1.000	110	0.232	205	0.069
20	0.992	115	0.213	210	0.065
25	0.980	120	0.196	215	0.062
30	0.966	125	0.181	220	0.060
35	0.947	130	0.168	225	0.057
40	0.920	135	0.156	230	0.055
45	0.883	140	0.145	235	0.052
50	0.829	145	0.136	240	0.050
55	0.759	150	0.127	245	0.048
60	0.681	155	0.119	250	0.046
65	0.605	160	0.112	255	0.045
70	0.536	165	0.105	260	0.043
75	0.475	170	0.099	265	0.041
80	0.423	175	0.094	270	0.040
85	0.378	180	0.089	275	0.038
90	0.340	185	0.084	280	0.037
95	0.307	190	0.080	285	0.036
100	0.279	195	0.076	290	0.035

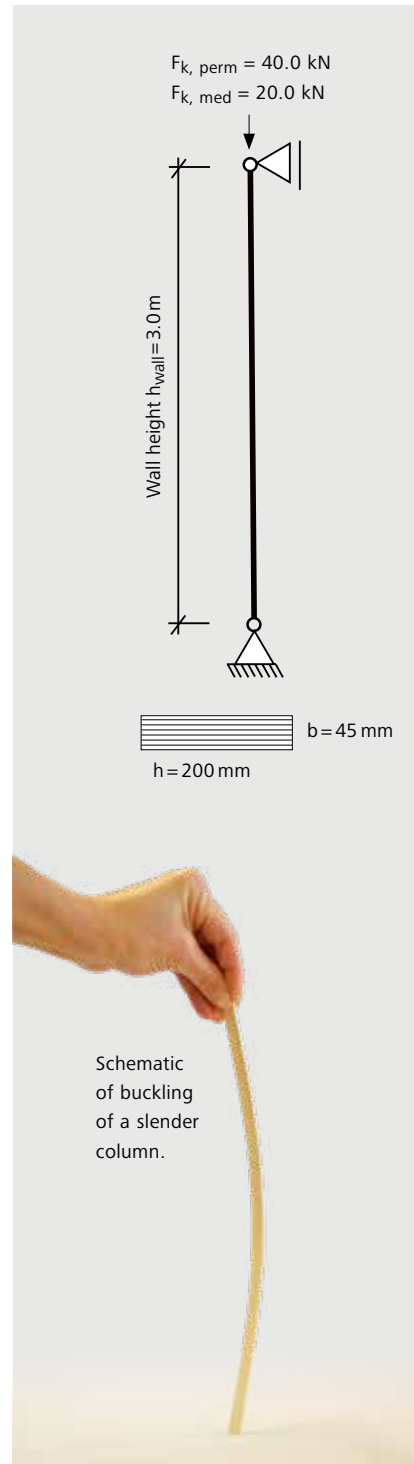

STEICO LVL R for wall studs

Load-bearing board joint on 45 mm STEICO LVL R wall stud

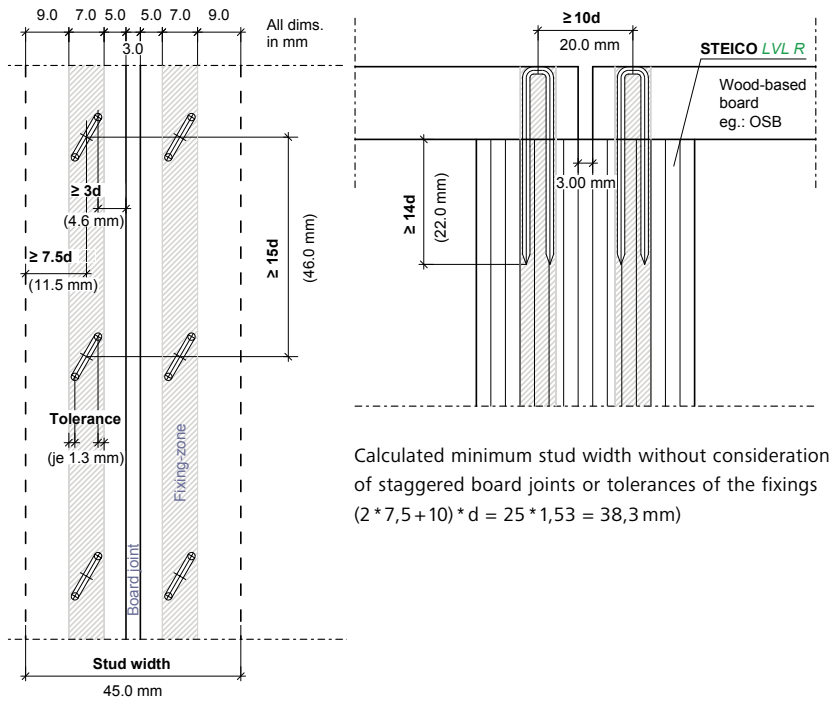

Staple geometry e.g. Haubold KG 700

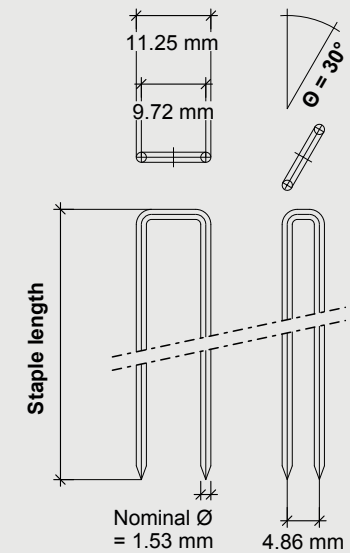

Schematic diagram of the board joint

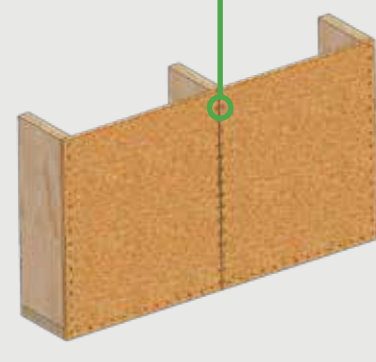
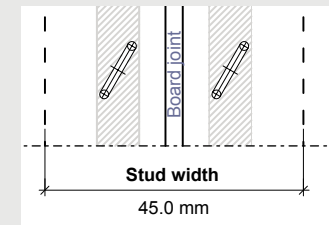

Slender wall studs STEICO LVL R



Minimum spacing and calculation of staple connections in STEICO LVL*

Spacing ¹ (see figure 8.10 in EN 1995-1-1)	Angle	Min. Spacing
a ₁ Spacing parallel to grain	0° ≤ α ≤ 360°	θ ≥ 30°: (10+5 · cos α) d θ < 30°: (15+5 · cos α) d
a ₂ (perpendicular to grain)	0° ≤ α ≤ 360°	θ ≥ 30°: (5+10 · sin θ) d θ < 30°: 10d
a _{3,t} (loaded end)	-90° ≤ α ≤ 90°	(15+ 5 · cos α) d
a _{3,c} (unloaded end)	90° ≤ α ≤ 270°	15d
a _{4,t} (loaded edge)	0° ≤ α ≤ 180°	(10 + 5 · sin α) d
a _{4,c} (unloaded edge)	180° ≤ α ≤ 360°	(5 + 5 · sin α) d

α is the angle of the load to the grain and θ the angle between the back of the staple and the grain

1) Definition of the minimum spacing on page 29

37% higher embedment strength compared to solid C24 timber which results in 10% fewer fixings

Embedment strength for staples in STEICO LVL Laminated Veneer Lumber

When calculating the load bearing strength to Eurocode 5 for staples in STEICO LVL, the characteristic embedment strength of staples that are fixed perpendicular to the grain can be calculated as follows: *

$$f_{h,k} = \frac{0,082 \cdot \rho_k \cdot d^{-0,3}}{k_c \cdot \cos^2 \beta + \sin^2 \beta} \text{ in N/mm}^2$$

In this context: ρ_k Characteristic raw density according to declaration of performance
ρ_k = 480 kg/m³ for STEICO LVL R and STEICO LVL X | d Nominal diameter of staple in mm | β Angle between staple shaft and board face | k_c=1 for STEICO LVL R, k_c=3 for STEICO LVL X (to d=3 mm) | The embedment depth into the small face of STEICO LVL should be a minimum of 12 d.

* According to the expert opinion of Univ.-Prof. Dr.-Ing. H. J. Blag from 23.04.2018; Adoption of rules into General Building Approval Z-9.1-842 for STEICO LVL Laminated Veneer Lumber applied for.

Material- and thermalbridge reduction using slender STEICO LVL R wall studs

The use of high load bearing STEICO LVL R wall studs, in combination with STEICO LVL sole plates, can result in significant material savings. This is made possible due to the high compression and bending strength of Laminated Veneer Lumber. The following table shows the material saving potential of using STEICO LVL R Laminated Veneer Lumber instead of wall constructions which utilize solid C24 timbers.

		Solid timber C24 for wall studs and sole/header plate	STEICO LVL R for wall studs and sole/header plates			
From stud depths of [mm]	Stud width [mm]	Middle stud 1		Edge stud 2		
		Stud width [mm]	Material saving against C24	Stud width [mm]	Material saving against C24	
120	60	45	25 %	45	25 %	
	80	45	44 %	45	44 %	
	100	45	55 %	57	43 %	
	120	45	63 %	57	53 %	
	140	57	59 %	75	46 %	
	160	75	53 %	45 + 45	44 %	
	180	45 + 45	50 %	57 + 45	43 %	
	200	57 + 45	49 %	57 + 57	43 %	

General information

From a stud depth of 120 mm the compression of the sole plate is critical (Examined Buckling length 3,0 m, in a braced wall). The bearing check uses a $k_{c,90}$ -value of 1,25 the same as solid timber. The increase factor for $f_{c,90,flat,k}$ in SC1 in accordance with AbZ Z-9.1-842 with $k=1,20$ was used. The increased contact length in accordance with DIN EN 1995-1-1 is considered with 30 mm on both sides of a middle stud and 30 mm on an edge stud.

Example calculation for wall stud

Solid Timber C24: 120 mm * 200 mm

Sole plate compression (middle stud):

$$\begin{aligned}
 R_{SWP,C24,k} &= f_{c,90,k} * A_{ef} * k_{c,90} \\
 &= 2,5 * 200 * (30+120+30) * 1,25 \\
 &= 112,5 \text{ kN}
 \end{aligned}$$

Buckling:

$$\begin{aligned}
 R_{buckling,C24,k} &= 388,9 \text{ KN} \geq 112,5 \text{ kN} \\
 &\rightarrow \text{Buckling not critical}
 \end{aligned}$$

STEICO LVL R 45 mm * 200 mm

Sole plate compression (middle stud):

$$\begin{aligned}
 R_{SWP,LVLR,k} &= f_{c,90,flat,k} * A_{ef} * k_{c,90} * k \\
 &= 3,6 * 200 * (30+45+30) * 1,25 * 1,20 \\
 &= 113,4 \text{ kN} \geq 112,5 \text{ kN} \quad \checkmark
 \end{aligned}$$

Buckling:

$$\begin{aligned}
 R_{buckling,LVLR,k} &= 289,2 \text{ KN} \geq 113,4 \text{ kN} \\
 &\rightarrow \text{Buckling not critical}
 \end{aligned}$$

Advantages of slender STEICO LVL R wall studs

- Up to 63 % less timber used
- Reduced cross section with minimal thermal bridge
- One product for sole plate and stud hence less stock requirement
- Up to 10% saving in fixings due to 37% higher embedment strengths
- Dry, stable material for accurate construction
- Reduced timber material for robust construction

Middle stud

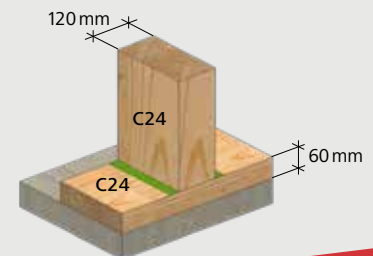

Material saving up to 63 %

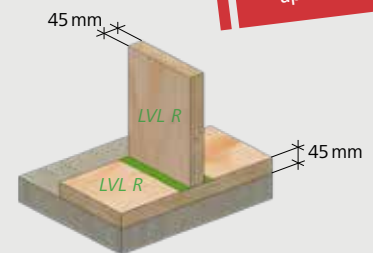

1

Edge stud

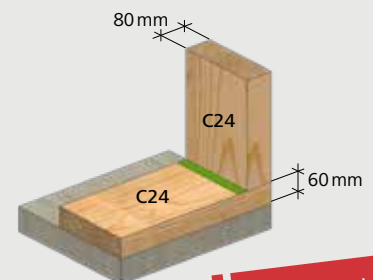

Material saving up to 44 %

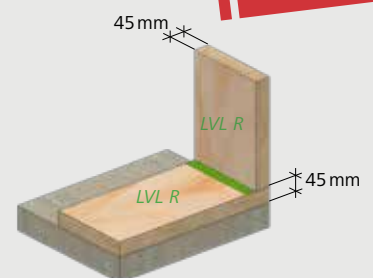

2

c STEICO LVL R as lintel

STEICO LVL R lintels for maximum loads



Traditional connections and details for lintels can be optimised through the use of STEICO LVL statically as well as in regards to building physics. Using intelligent design, filigree members can be used, which offer multiple advantages.

Advantages at a glance

Bending strength and elastic modulus parallel to the grain with edgewise application **1**

- STEICO LVL R: $f_{m,0,edge,k} = 44.0 \text{ N/mm}^2$
- STEICO LVL R: $E_{0,mean} = 14,000 \text{ N/mm}^2$

Compressive strength perpendicular to the grain with edgewise application **2**

- STEICO LVL R: $f_{c,90,edge,k} = 7.5 \text{ N/mm}^2$

Lintel details for large wall depths a/b

- Lintels in addition to shading
- Studs can be interrupted
- Slim lintels, static height optimized
- Design as single span or multiple-span beam
- Reduced material usage
- Improved detailing in regards to building physics

Lintel details for small wall depths c

- Exchange of steel beams without design changes
- Simpler details when compared to using steel beams
- Reduced section height compared to glued laminated timber members
- Reduced bearing lengths compared to glued laminated timber (reduced stud cross section)
- Design as single span or multiple-span beam
- Block-laminated STEICO G LVL R beams or mechanically jointed multi-part STEICO LVL R beams possible

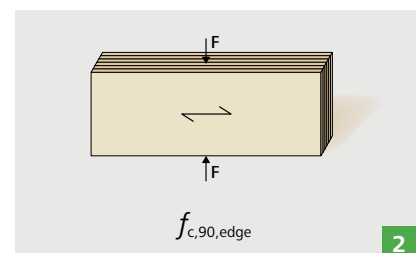
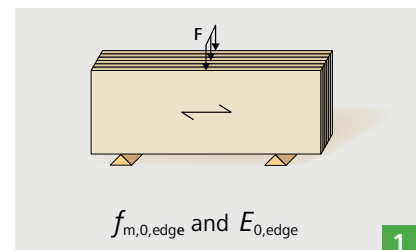

Lintel details

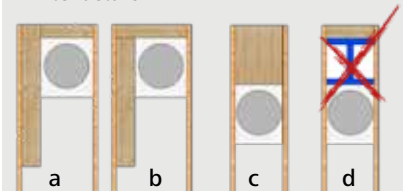

a/b: Lintel details for large wall depths as single span or multiple-span beam

c: Lintel details for small wall depths

d: Lintel detail using steel beams – not desirable in wood construction

STEICO LVL R as lintel

Multi-part STEICO LVL R beams, mechanically connected 1

- For uniformly distributed loads, it is sufficient to connect the individual STEICO LVL R strips with nails, screws or dowels.

Design examples

a STEICO LVL R lintel installed edgewise as a single-span beam

- Lintel as a single-span beam just over the openings
- Wall studs without notches in areas without openings



b STEICO LVL R lintel installed edgewise as multi span beam

- Continuous lintel as multi span beam
- floor joists spacing independent of the wall stud locations



c Glued multi-part STEICO G LVL R lintel as continuous beam

- Lintel as a single-span or multi-span continuous beam
- Floor joists spacing independent of the wall stud locations

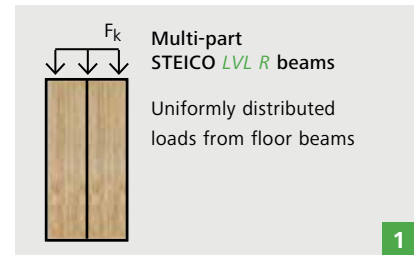

Notched stud with continuous lintel



Notched stud with continuous top plate and lintel



Glued multi-part STEICO G LVL R lintel as continuous top plate

STEICO LVL R as lintel

Preliminary design of STEICO LVL R as lintel

Based on the reference building for the variant **a** (STEICO LVL R as wall lintel installed edgewise as a single-span beam) the STEICO LVL R lintel is designed. The table shows the maximum clear opening and the required bearing length (depth of stud at the opening).

Beam width [mm]	Beam height $h_{Träger}$ [mm]	Lintel installed edgewise as a single-span beam	
		Maximum clear opening l [m]	Required bearing length l_A [mm]
STEICO LVL R $b = 1 \times 45$ mm	200	1.45	45
	240	1.75	57
	280	2.05	75
	300	2.20	80
STEICO LVL R $b = 1 \times 57$ mm	200	1.60	45
	240	1.95	45
	280	2.30	60
	300	2.45	75
STEICO LVL R $b = 1 \times 75$ mm	200	1.80	45
	240	2.15	45
	280	2.55	45
	300	2.70	57
STEICO LVL R $b = 2 \times 45$ mm	200	1.95	45
	240	2.35	45
	280	2.75	45
	300	2.90	45
STEICO LVL R $b = 2 \times 57$ mm	200	2.10	45
	240	2.55	45
	280	3.00	45
	300	3.20	45
STEICO LVL R $b = 2 \times 75$ mm	200	2.35	45
	240	2.80	45
	280	3.30	45
	300	3.55	45

Support condition **1**

The design check in the lintel section on the wall stud will be done out with a $k_{c,90}$ value of 1.0. The bearing on the sole plate and the buckling of the stud have to be checked separately, see tables on pages 7 and 9. For two-part lintels, the load has to be equally transferred to both parts.

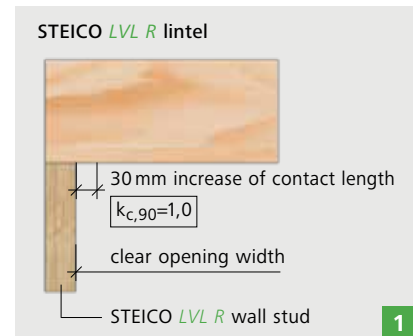
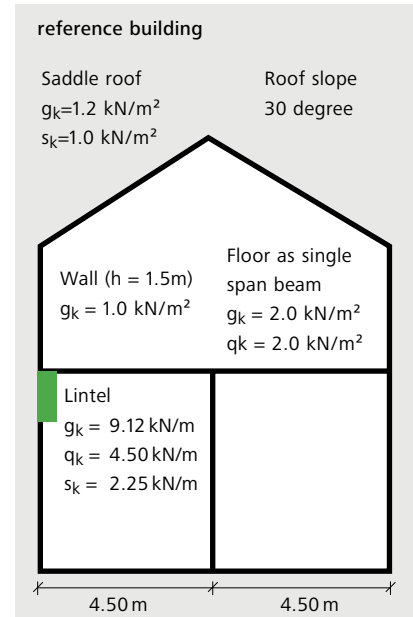

Boundary conditions

Service class = 1
 Live load:
 Category A (Load duration class = medium)
 Snow load: the building is
 ≤ 1000 m above sea level
 (Load duration class = short)

Serviceability Limit State check (SLS):

Done in accordance with clause 7.2 of
 DIN EN 1995-1-1.

Deflection limits are based on:

$w_{inst} \leq l/400$
 $w_{net,fin} \leq l/400$
 $w_{fin} \leq l/300$

In certain cases, where these limits might be too generous, we recommend that you make specific arrangements with the owner in advance.

Ultimate Limit State check (ULS):

Checks for bending and shear according to DIN EN 1995-1-1. It is assumed that the compression side is supported to prevent buckling. The tables and its valued do not substitute the static design check.

STEICO *LVL X* as rimboard: Prevention of settlements at storey interface



In order to avoid compression wrinkles in the facade, settlements at storey interfaces must be prevented constructively. The use of STEICO *LVL X* as rimboard reduce the amount of wood in compression perpendicular to the grain and ensure a perfect load transfer. In combination with a slender STEICO *LVL* sole and top plate, a highly resilient and dimensionally stable interface is generated, which prevents any settlement.

Advantages at a glance

Compressive strength perpendicular to the grain in edgewise application: 1

- STEICO *LVL X*: $f_{c,90,edge,k}=9.0 \text{ N/mm}^2$

Swelling and shrinkage

- Delivery moisture content = Equilibrium moisture content at use, thus no shrinkage and swelling
- With STEICO *LVL X* approx. 20 % of the veneer layers are vertical
- Dimensionally stable component

Avoiding settlements

- High compressive strengths in edgewise application
- Very small compression (high compression modulus of elasticity)
- Secure load transfer thanks to cross-wise veneers
- No settlements, thus compression wrinkles in the facade are prevented

Reduced cross section 2

- Due to the high compressive strength, the cross-section can be significantly reduced compared to solid timber of strength class C24

Further advantages of STEICO *LVL X* as rimboard

- Rimboard to prevent tilting of joists
- Can be connected in the edge face
- No rimboard splicing required
- Continuous rimboard required for diaphragm behaviour (absorption of tensile forces from the floor)
- Optimal in combination with slender STEICO *LVL* sole and top plates (reduction of wood loaded perpendicular to the grain)

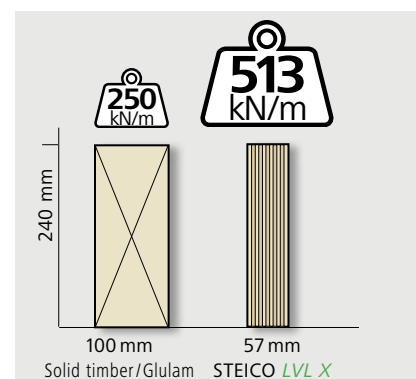
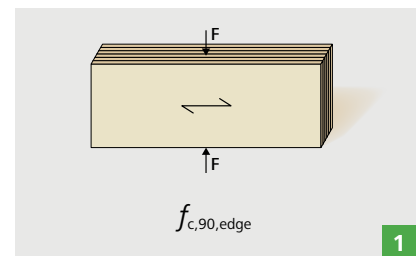

"Half the cross-section – twice the load-carrying capacity"

1 meter rimboard made of solid timber C24 resp. Glulam (all classes) with a cross-section 100/240 mm has a characteristic compression capacity of 250 kN/m. The strength and stiffness of STEICO *LVL X* due to the cross-wise veneer layers is significantly higher. A STEICO *LVL X* rimboard with a width of only 57 mm can carry 513 kN/m.

2

STEICO LVL X as rimboard

STEICO LVL X: Design advantages though direct floor support

Comparison between balloon-type construction (C24/Glulam) and construction with direct floor support (STEICO LVL X)		
	Balloon-frame construction (C24/Glulam)	Direct floor support with STEICO LVL X rimboard
Simple and cost-effective fastening technology	✗	✓
Sound insulation	✗	✓
Same internal and external wall heights, thus same panel sizes and stud length	✗	✓
Cost savings through possible avoidance of installation level	✗	✓
Direct support for "simple" load transfer	✗	✓
Air tightness	✓	✓
Dimensional stability	✓	✓
Effort	High	Low

Platform-type construction offers a significantly more economical solution for timber houses. The mounting of floor elements on the wall element can be realized more efficiently, the direct bearing also permits designing for a simpler load path. This type of construction is also superior in terms of sound insulation.

STEICO LVL X: Highest safety for timber construction

Comparison of different wood products when used as rimboard			
	Solid timber C24	Glued laminated timber (all classes)	STEICO LVL X Laminated Veneer Lumber
Compressive strength perpendicular to the grain	2.5 N/mm ² 100%	2.5 N/mm ² 100%	9.0 N/mm ² 360%
Wood moisture content at delivery	up to 18%	up to 15%	approx. 9%
Possible shrinkage for cross-section height of 300 mm	up to 7 mm	up to 5 mm	0 mm
Swelling and shrinkage coefficient in % for 1% change of wood moisture content (lower = better)	0.25	0.25	0.03
Processing without pre-drilling	yes	yes	yes
Free weathering during the construction phase	yes	yes	yes
Suitable as rimboard	With restrictions	With restrictions	yes

STEICO LVL X as rimboard combines dimensional stability, high strength and easy processing – STEICO LVL X is therefore the best choice for modern timber constructions with the highest precision.

Solid timber C24 – Significant shrinkage

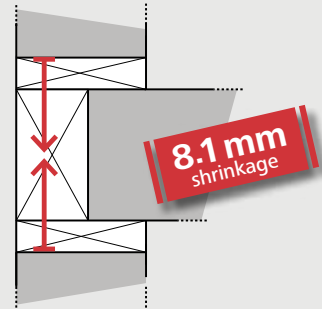

Height of rimboard (C24)	240 mm
Depth of sole and top plate of the adjacent wall elements (C24)	60 mm
Permissible wood moisture content at delivery	up to 18%
Swelling and shrinkage coefficient in % for 1% change of wood moisture content	0.25
Equilibrium moisture content during use	approx. 9%
Change of moisture content	-9%
Shrinkage	up to 8.1 mm

STEICO LVL X – completely dimensionally stable

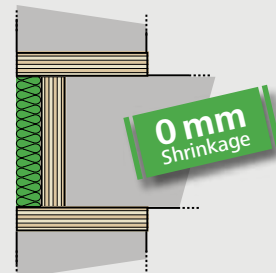

Height of rimboard (LVL X)	240 mm
Depth of sole and top plate of the adjacent wall elements (LVL X/R)	45 mm
Permissible wood moisture content at delivery	approx. 9%
Swelling and shrinkage coefficient in % for 1% change of wood moisture content	0.03
Equilibrium moisture content during use	approx. 9%
Change of moisture content	0%
Shrinkage	0 mm

Floor structures with STEICO *LVL*: Economical, wide-span floor structures



The use of STEICO *LVL R* enables economic, wide-span floor structures. Thanks to the high strength and stiffness combined with the available slender cross-sections, STEICO *LVL R* is ideally suited for floor applications.

STEICO *LVL* as joist: advantages

Bending strength and longitudinal modulus of elasticity for edgewise application **1**

- STEICO *LVL R*: $f_{m,0,edge,k} = 44.0 \text{ N/mm}^2$
- STEICO *LVL R*: $E_{mean} = 14,000 \text{ N/mm}^2$

Wide-span floor structures **2**

- High stiffness
- High strength

Technically refined product

- Straight product, no pre-deformation
- Dry and dimensionally stable, thus no risk of shrinkage cracks
- Slender cross-sections, thus low weight

Small bearing lengths

- High compressive strength perpendicular to the grain if used in edgewise application
- Supports in the installation level possible
- Point supports possible without the use of steel plates
- Load bearing dovetailed connection according to the German Technical Approval AbZ Z-9.1-649 possible

Planning security

- STEICO *LVL R* joists are available in many heights, no change of material required as for solid timber (for example, change to glued laminated timber)
- Recommended slenderness = 1/8
- e.g.: STEICO *LVL R* 75 mm * 600 mm or 45 mm * 360 mm

Joists for heavy floors

- Floors with a natural frequency $\leq 8 \text{ Hz}$ are possible
- Special investigations, e.g. According to Information sheet 02.04 by the Federal Association of German Prefabricated Buildings (BDF)
- Larger spans possible if the required boundary conditions are met

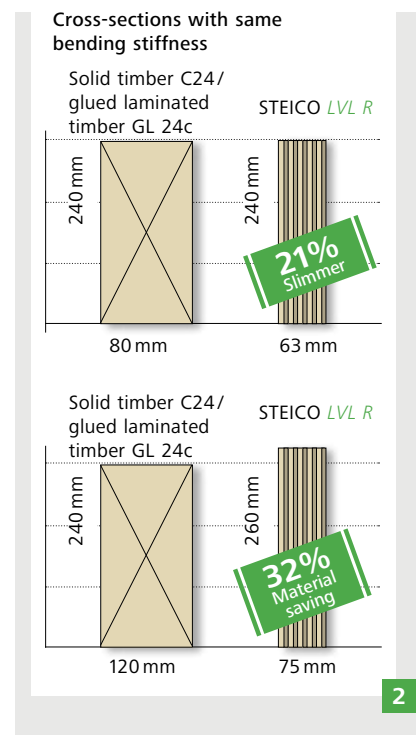
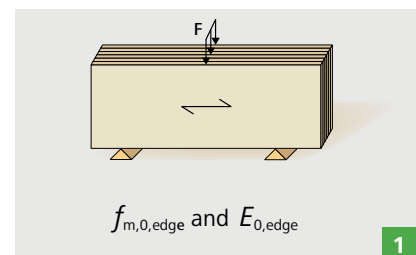

STEICO LVL for floor structures

Floor construction for false ceiling with wet screed **1**

- 1 Floor covering = 0.10 kN/m²
 - 2 Wet screed 5 cm = 1.20 kN/m²
 - 3 STEICO^{therm} SD wood fiber insulation board = 0.05 kN/m²
 - 4 Wood material panel = 0.15 kN/m²
 - 5 STEICO LVL R beam with 100 mm STEICO^{flex} = 0.30 kN/m²
 - 6 Gypsum board 12.5 mm on spring clips = 0.20 kN/m²
- Total dead load g_k = 2.0 kN/m²

Floor construction for false ceiling with wet screed system and filling **2**

- 1 Floor covering = 0.10 kN/m²
 - 2 Wet screed 5 cm = 1.20 kN/m²
 - 3 STEICO^{therm} SD wood fiber insulation board = 0.05 kN/m²
 - 4 Bounded filling = 0.75 kN/m²
 - 5 Wood material panel = 0.15 kN/m²
 - 6 STEICO LVL R beam with 100 mm STEICO^{flex} = 0.30 kN/m²
 - 7 Gypsum board plate 12.5 mm on spring clips = 0.20 kN/m²
- Total dead load g_k = 2.75 kN/m²

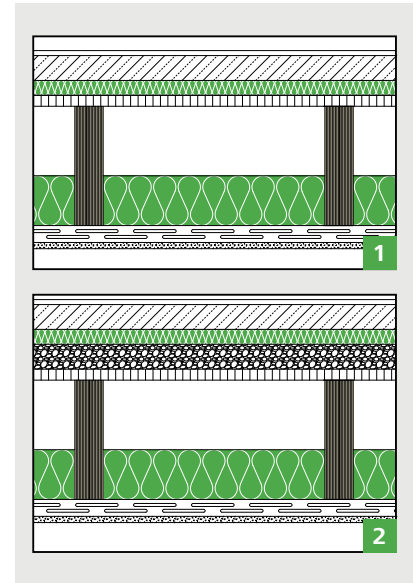

Maximum span in meters [m] for single-span beams when using STEICO LVL R

Vibration performance considered Life load $q_k=2.8\text{ kN/m}^2$

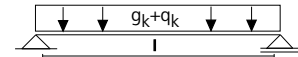

Thickness [mm]	Height H [mm]	Dead load $g_k=2.00\text{ kN/m}^2$ 1			Dead load $g_k=2.75\text{ kN/m}^2$ 2		
		Joist spacing [cm]			Joist spacing [cm]		
		41.7	50.0	62.5	41.7	50.0	62.5
STEICO LVL R 45	200	3.75	3.55	3.25	3.50	3.30	3.05
	220	4.05	3.85	3.60	3.75	3.60	3.35
	240	4.30	4.15	3.90	4.00	3.80	3.60
	280	4.85	4.65	4.40	4.45	4.30	4.05
	300	5.10	4.85	4.60	4.70	4.50	4.25
	360	5.85	5.55	5.25	5.40	5.15	4.90
	400	6.30	6.05	5.70	5.85	5.55	5.25
STEICO LVL R 57	200	4.00	3.80	3.55	3.70	3.55	3.35
	220	4.30	4.10	3.90	3.95	3.80	3.60
	240	4.60	4.40	4.15	4.25	4.05	3.85
	280	5.15	4.90	4.65	4.75	4.55	4.30
	300	5.40	5.15	4.90	5.00	4.75	4.50
	360	6.20	5.90	5.60	5.70	5.45	5.15
	400	6.70	6.40	6.05	6.20	5.90	5.60
STEICO LVL R 75	200	4.30	4.10	3.85	3.95	3.80	3.60
	220	4.60	4.40	4.15	4.25	4.05	3.85
	240	4.90	4.70	4.45	4.55	4.35	4.10
	280	5.50	5.25	4.95	5.05	4.85	4.60
	300	5.80	5.50	5.25	5.35	5.10	4.85
	360	6.60	6.35	6.00	6.10	5.85	5.50
	400	7.15	6.85	6.45	6.60	6.30	6.00

Boundary conditions

Exposure: Service Class = 1

Live load category = A

Load duration class = medium

Calculation using STEICO^{xpress}

Serviceability Limit State check (SLS):

This check is done in accordance with clauses 7.2 and 7.3 of DIN EN 1995-1-1 under consideration of the German National Application Document (version 2013):

$$w_{inst} \leq l / \dots\dots\dots 300$$

$$w_{net,fin} \leq l / \dots\dots\dots 300$$

$$w_{fin} \leq l / \dots\dots\dots 200$$

Limit frequency for vibration performance (ULS):

$$f_1, \text{ Limit} > 8.0 \text{ Hz}$$

Ultimate Limit State check (ULS):

One-way bending and shear are considered. Bearing pressure, wind and point loads are not considered in the table values. These tables are to be used for preliminary design and do not replace a static design check.

STEICO LVL for floor structures: Advantages

For large-span floors where conventional constructions reach their performance limits, composite floor systems offer an interesting and economical alternative – Composite systems consisting either of STEICO LVL X sheathing, STEICO LVL R ribs or mass-panel elements from STEICO G LVL R.

Composite structures

- Static activation of STEICO LVL X sheathing for vertical load transfer
- Stiffening and fast production thanks to large-format STEICO LVL X panels
- Wide-span floor construction for flexible, open floor plan design
- Manual production of mechanically joined composite elements using clamps, nails or screws
- Production of glued elements by certified producer, glue certification C2 according to DIN 1052-10

Composite construction: STEICO LVL X rib elements **1**

- Top sheathing: STEICO LVL X
- Rib: STEICO LVL R
- Composite action: mechanically joined or glued

Composite construction: STEICO LVL box elements **2**

- Top and bottom sheathing: STEICO LVL X
- Rib: STEICO LVL R
- Composite action: mechanically joined or glued

Mass-panel elements

STEICO G LVL R Solid floor panel **3**

- Multiple glued STEICO LVL R ribs
- High-strength element for large spans
- Appealing fineline look

Comparison of spans for different floor systems

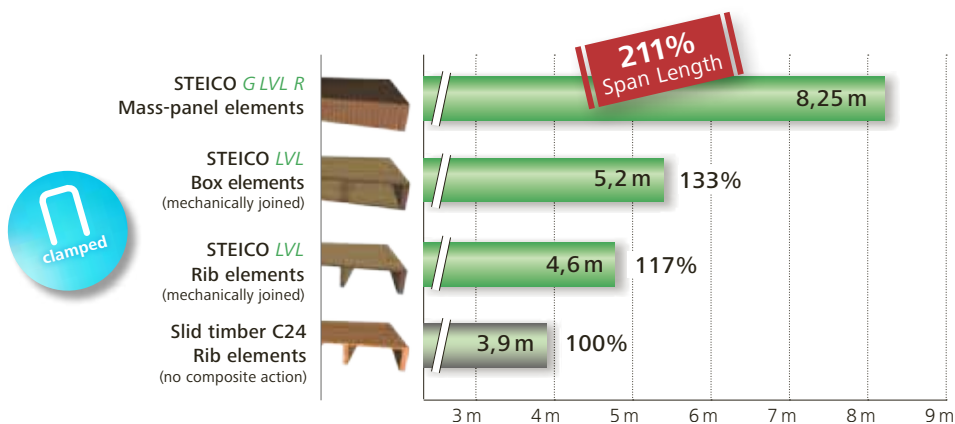

Boundary conditions:

Single-span beams | Service class 1 | Category A | Dead load $g_k = 2.20 \text{ kN/m}^2$ | Life load $q_k = 2.0 \text{ kN/m}^2$ | Limit frequency for vibration performance $> 8 \text{ Hz}$ | Spacing of the ribs $e = 625 \text{ mm}$ | Rib height $h_w = 240 \text{ mm}$ and $h_{LVL \text{ solid}} = 280 \text{ mm}$ | Rib width $b_w, C24 = 60 \text{ mm}$ and $b_w, LVL R = 57 \text{ mm}$ | STEICO LVL X sheathing $t = 27 \text{ mm}$ | Mechanical fasteners: wire clamp $d = 2.0 \text{ mm}$, clamp length $l = 70 \text{ mm}$, clamp spacing $s_{VM} = 30 \text{ mm}$



Manual production

Mechanically joined composite elements using clamps, nails or screws. (No glue certification required.)

STEICO LVL Rib Elements

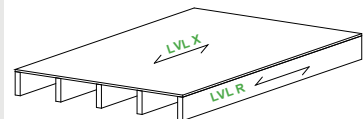

1

STEICO LVL Box elements

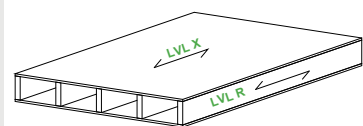

2

STEICO G LVL R Mass-panel elements

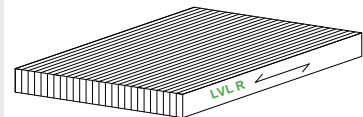

3

Product certified according to German Technical Approval AbZ Z-9.1-870

F STEICO LVL X as roof and floor diaphragm

Roof and floor diaphragm: high strength and high stiffness



Roof and floor diaphragm made of STEICO LVL X are used as load-bearing sheathing and as stiffening diaphragm. Due to the high strength and stiffness in combination with the available dimensions (large format panels) STEICO LVL X is exceptionally suitable for these applications. Furthermore, special applications like curved components can be used according to the German technical approval AbZ Z-9.1-842.

Advantages at a glance

Bending strength parallel to the grain and longitudinal modulus of elasticity for upright application ($t \geq 27$ mm) **1**

- STEICO LVL X: $f_{m,0,flat,k} = 36.0$ N/mm²
- STEICO LVL X: $E_{0,mean} = 10,600$ N/mm²

Shear strength when used as diaphragm

- STEICO LVL X: $f_{v,edge,k} = 4.6$ N/mm²

High strength and stiffness **2**

- Increased spacing of joists and purlins
- Improved load-distribution, positive for the vibration performance
- Easy installation of fasteners without pre-drilling

Large format panels available **3**

- Widths up to 2.5 m and lengths up to 18 m
- Plate thickness up to 63 mm
- Enables multiple-span systems
- Accelerated installation, less work steps
- Reduction in number of plate joints

Further advantages of STEICO LVL X as roof and floor diaphragm

- Dimensional stability through approx. 20% cross-wise layers
- Reduced creep compared to OSB and particle boards

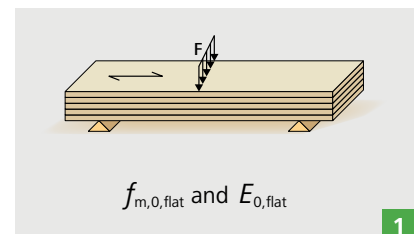
**1**

Increased spacing of joists and purlins

**2**

Quick installation thanks to large format panels

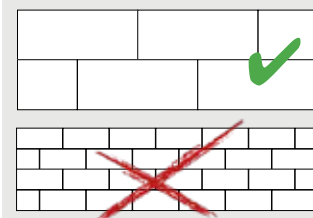

Reduction in number of plate joints and accelerated installation with less work steps thanks to large-format panels with widths of up to 2.5 m and lengths up to 18 m.

3

STEICO LVL X as roof and floor diaphragm

Preliminary dimensioning of STEICO LVL X as roof boarding

Maximum span as single-span beam/plate spanned in the direction of the strong axis

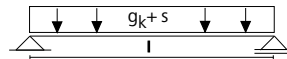

	Metal roof 1			Gravel roof 2		
Dead load [kN/m ²]	0.35			2.0		
Snow load [kN/m ²]	0.52	0.68	0.88	0.52	0.68	0.88
Plate thickness [mm]	maximum span l [m]					
27	1.70	1.70	1.65	1.05	1.05	1.05
33	2.05	2.05	2.00	1.30	1.30	1.30
39	2.35	2.35	2.35	1.50	1.50	1.50
45	2.70	2.70	2.65	1.75	1.75	1.75
51	3.00	3.00	3.00	1.95	1.95	1.95
57	3.30	3.30	3.30	2.20	2.20	2.20
63	3.55	3.55	3.55	2.40	2.40	2.40
69	3.85	3.85	3.85	2.60	2.60	2.60



Maximum span as double-span beam/plate spanned in the direction of the strong axis

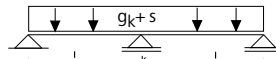

	Metal roof 1			Gravel roof 2		
Dead load [kN/m ²]	0.35			2.0		
Snow load [kN/m ²]	0.52	0.68	0.88	0.52	0.68	0.88
Plate thickness [mm]	maximum span l [m]					
27	2.20	2.10	1.95	1.40	1.40	1.40
33	2.70	2.55	2.40	1.70	1.70	1.70
39	3.15	3.00	2.85	2.05	2.05	2.05
45	3.60	3.45	3.25	2.35	2.35	2.35
51	4.00	3.85	3.65	2.65	2.65	2.65
57	4.40	4.25	4.10	2.95	2.95	2.95
63	4.80	4.70	4.50	3.25	3.25	3.25
69	5.15	5.10	4.90	3.50	3.50	3.50



Construction metal roof



- 1 Metal sheet = 0,34 kN/m²
- 2 Fiber board = 0,01 kN/m²
- 3 STEICO LVL X = automatic

$$g_{\text{total, k}} = 0.35 \text{ kN/m}^2$$

1

Construction gravel roof



- 1 Gravel layer (6 cm) = 1.20 kN/m²
- 2 Sealing = 0.07 kN/m²
- 3 STEICOroof = 0,60 kN/m²
- 4 Vapour barrier = 0.07 kN/m²
- 5 STEICO LVL X = automatic

$$g_{\text{total, k}} = 2.0 \text{ kN/m}^2$$

2

Ceiling beams = STEICO LVL R
Roof boarding = STEICO LVL X

Boundary conditions

Service class = 2

Load duration class = short

(Building height above sea level ≤ 1000 m)

Roof slope: α = 0 degrees

The dead weight of the STEICO LVL X panels has already been taken into account and therefore does not have to be added.

For more detailed information on building physics considerations when using veneer laminated wood in a flat roof structure, please refer to the publication "Flat roofs in wood construction" by Informationsdienst Holz.

Serviceability Limit State check (SLS):

These checks are done in accordance with clause 7.2 of DIN EN 1995-1-1 under consideration of the German National Application Document (version 2013):

$$w_{\text{inst}} \dots \dots \dots \leq l/200$$

$$w_{\text{net, fin}} \dots \dots \dots \leq l/250$$

$$w_{\text{fin}} \dots \dots \dots \leq l/150$$

In certain cases, where these limits might be too generous, we recommend that you make specific arrangements with the owner in advance.

Ultimate Limit State check (ULS):

One-way bending and shear as for man-load are considered according to DIN EN 1995-1-1 and DIN EN 1991-1/NA: 2010 Tab. 6.10

The snow load was reduced by the coefficient μ for roof slopes of 0° ≤ α ≤ 30° and uniformly distributed.

Bearing pressure, wind and point loads are not considered in the table values.

These tables are to be used for preliminary design and do not replace a static design check.

G STEICO LVL X as roof overhang

STEICO LVL X as roof overhang: slender, elegant and strong



Slender overhangs with fine roof lines can be realized economically and simply with STEICO LVL X panels. It is recommended to take the panel orientation and joints into consideration during the design stage. The largest deflections are to be expected at the corner areas, for which special solutions are offered.

Advantages at a glance

Bending strength **parallel** to the grain and longitudinal modulus of elasticity for flatwise application ($t \geq 27$ mm) **1**

- STEICO LVL X: $f_{m,0,flat,k} = 36.0$ N/mm²
- STEICO LVL X: $E_{0,mean} = 10,600$ N/mm²

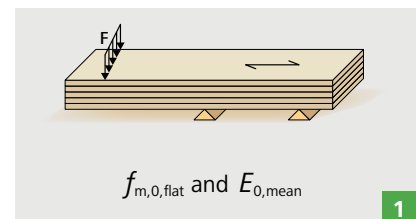

Bending strength **perpendicular** to the grain and transverse modulus of elasticity for flatwise application ($t \geq 27$ mm) **2**

- STEICO LVL X: $f_{m,90,flat,k} = 8.0$ N/mm²
- STEICO LVL X: $E_{m,90,flat,mean} = 2,500$ N/mm²

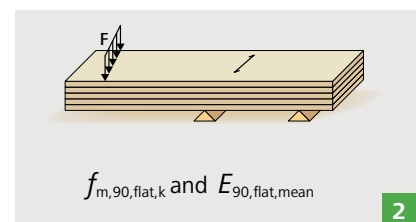

Architecturally appealing roof detailing

- Fine-line continuous roof lines
- Application for steep and flat roofs
- Large format panel dimensions, reduction of panel joints
- Roof overhangs of up to 2.0 m possible

Connections

- Simple connection details to the façade
- No flying rafters and stillage boards required
- Easy prefabrication
- Additional connections around rafters are omitted

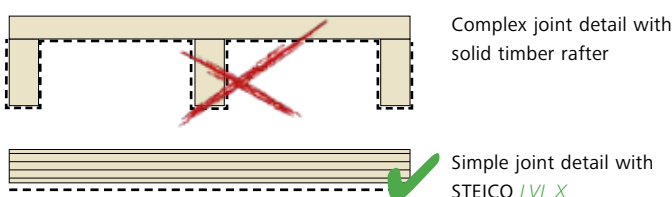

Possibilities of panel joint detailing

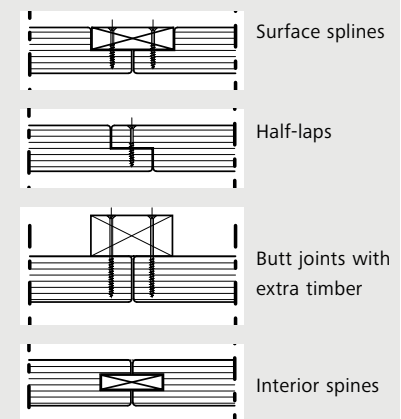

STEICO LVL X as roof overhang

Preliminary design of STEICO LVL X as overhang panels

Minimum panel thickness t in mm for STEICO LVL X in regular overhang areas
 Panel spanning in the direction of the strong axis

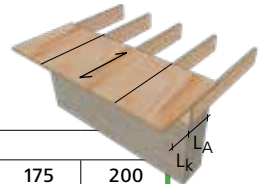

Loads [kN/m ²]		Overhang length l_k [cm]											
Dead load	Snow load	40	50	60	70	80	90	100	110	125	150	175	200
$g_k = 0.15$	$s_k = 0.52$	27	27	27	27	27	27	33	33	39	45	51	57
	$s_k = 0.68$	27	27	27	27	27	27	33	33	39	45	51	60
	$s_k = 0.88$	27	27	27	27	27	33	33	39	39	45	57	63
$g_k = 0.65$	$s_k = 0.52$	27	27	27	27	27	33	33	39	45	51	57	63
	$s_k = 0.68$	27	27	27	27	27	33	39	39	45	51	63	69
	$s_k = 0.88$	27	27	27	27	33	33	39	39	45	57	63	69
$g_k = 1.5$	$s_k = 0.52$	27	27	27	33	33	39	39	45	51	63	69	-
	$s_k = 0.68$	27	27	27	33	33	39	45	45	51	63	69	-
	$s_k = 0.88$	27	27	27	33	33	39	45	45	51	63	-	-

Minimum panel thickness t in mm for STEICO LVL X in regular overhang areas
 Panel spanning in the direction of the weak axis

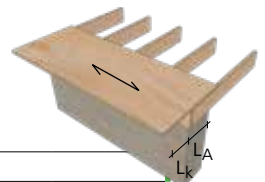

Loads [kN/m ²]		Overhang length l_k [cm]									
Dead load	Snow load	40	50	60	70	80	90	100	110	125	
$g_k = 0.15$	$s_k = 0.52$	27	27	27	33	39	45	45	51	57	
	$s_k = 0.68$	27	27	33	33	39	45	51	51	63	
	$s_k = 0.88$	27	27	33	39	45	45	51	57	63	
$g_k = 0.65$	$s_k = 0.52$	27	27	33	39	45	51	51	57	69	
	$s_k = 0.68$	27	27	33	39	45	51	57	63	69	
	$s_k = 0.88$	27	33	39	39	45	51	57	63	69	
$g_k = 1.5$	$s_k = 0.52$	27	33	39	45	51	57	63	69	-	
	$s_k = 0.68$	27	33	39	45	51	57	63	-	-	
	$s_k = 0.88$	27	33	39	51	57	63	69	-	-	

Minimum panel thickness t in mm for STEICO LVL R in overhang corner areas
 Panel reinforcement when spanning in the direction of the strong axis

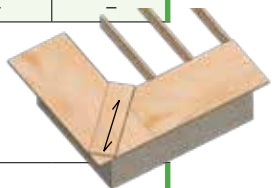

Loads [kN/m ²]		Overhang length l_k [cm]									
Dead load	Snow load	40/40	50/50	60/60	70/70	80/80	90/90	100/100	110/110	125/125	
$g_k = 0.15$	$s_k = 0.52$	27*215	27*275	27*340	33*300	33*530	39*520	45*520	51*530	57*670	
	$s_k = 0.68$	27*215	27*275	27*340	33*340	39*350	39*580	45*580	51*590	57*720	
	$s_k = 0.88$	27*215	27*275	27*380	33*385	39*400	45*420	45*660	51*670	57*820	
$g_k = 0.65$	$s_k = 0.52$	27*220	27*290	33*275	39*315	39*565	45*600	51*640	57*680	63*885	
	$s_k = 0.68$	27*220	27*290	33*275	39*315	39*565	45*600	51*640	57*680	63*885	
	$s_k = 0.88$	27*220	27*290	33*275	39*315	39*565	45*600	51*640	57*680	63*885	
$g_k = 1.5$	$s_k = 0.52$	27*235	33*230	39*295	45*360	51*430	57*500	60*670	69*645	75*870	
	$s_k = 0.68$	27*235	33*230	39*295	45*360	51*430	57*500	60*670	69*645	75*870	
	$s_k = 0.88$	27*235	33*230	39*295	45*360	51*430	57*500	60*670	69*645	75*870	

Design example

1. Input values: E.g. dead load $g_k = 0.65 \text{ kN/m}^2$; Snow load on the roof $s_k = 0.68 \text{ kN/m}^2$; Overhang length $l_k = 60 \text{ cm}$

2. Define STEICO LVL X panel thickness (from tables)

Regular overhang areas with panel spanning in the direction of the strong axis: $t = 27 \text{ mm}$,

Regular overhang areas with panel spanning in the direction of the weak axis: $t = 33 \text{ mm}$,

STEICO LVL R corner reinforcement (from table) $t = 33 \text{ mm}$ and $b = 275 \text{ mm}$

STEICO LVL X as roof overhang

Detailing of corner reinforcement

The corner detail is to be designed separately, because here the projection is diagonally measured greater than in the regular areas. As simple measure, a corner reinforcement from STEICO LVL R can be used. This reinforcement has the advantage that the regular areas can be used for the design of the overhang and a one-dimensional replacement system can be used for the calculation.

Design recommendation

Since overhang structures cool down significantly overnight, STEICO recommends an additional top insulation of the STEICO LVL X panels. This minimizes condensation on the underside of the overhang. STEICO *universal* panels can be used for this insulation. Further recommendations are included in the publication 5-2-2 "Wood protection – structural measures" from German "Informationsdienst Holz" (Timber Information Service).

STEICO LVL X is a structural product, the veneers are primarily sorted according to strength criteria, therefore a surface sheathing is recommended.

Refraining from surface sheathing, a coating system is required and should be planned carefully. Information on suitable coating systems is provided e.g. by the company Remmers (transparent or opaque coating available).

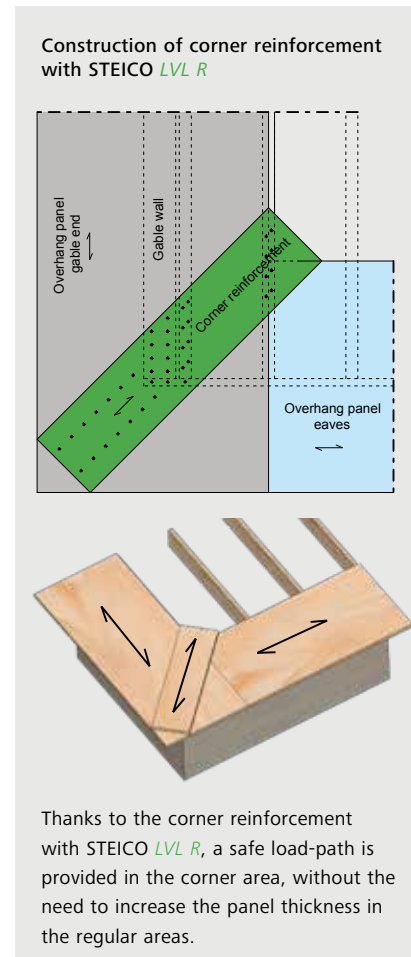

Boundary conditions

Service Class = 2

Load duration class = short
(Building height above sea level ≤ 1000 m)

Rood slope: $\alpha = 0$ degrees

Anchoring the overhang: $L_k \leq L_A$

Considered wind load: $w_k = 0.325 \text{ kN/m}^2$

Considered man load: $Q_k = 1.0 \text{ kN}$

Static system: fixed cantilever

Panel weight is taken into account

Serviceability Limit State check (SLS):

These checks are done in accordance with clause 7.2 of DIN EN 1995-1-1 under consideration of the German National Application Document (version 2013):

$$w_{inst} \dots \dots \dots \leq l/150$$

$$w_{net,fin} \dots \dots \dots \leq l/150$$

$$w_{fin} \dots \dots \dots \leq l/100$$

In certain cases, where these limits might be too generous, we recommend that you make specific arrangements with the owner in advance.

Ultimate Limit State check (ULS):

One-way bending and shear as for man-load are considered according to EN 1995-1-1.

Bearing pressure and connection forces are not considered in the table values.

The table values are valid only for linearly supported panels.

These tables are to be used for preliminary design and do not replace a static design check

Mechanical properties of STEICO LVL

Mechanical properties of STEICO LVL

The following table summarizes the STEICO LVL characteristic strength and stiffness properties in N/mm². In addition, other characteristics of STEICO LVL R and STEICO LVL X are included. The respective symbols are identified in the figures on the next page.

Main parameters	Symbol	Figure	Unit	STEICO LVL R	STEICO LVL X (t ≤ 24 mm)	STEICO LVL X (t ≥ 27 mm)
Bending strength						
Edgewise, parallel to grain (depth 300 mm)	$f_{m,0,edge,k}$	A	N/mm ²	44	30	32
Size effect parameter	s	–		0.15	0.15	0.15
Edgewise, perpendicular to grain (depth 300 mm)	$f_{m,90,edge,k}$	B	N/mm ²	NPD	10	8
Flatwise, parallel to grain	$f_{m,0,flat,k}$	C	N/mm ²	50	32	36
Flatwise, perpendicular to grain	$f_{m,90,flat,k}$	D	N/mm ²	NPD	7	8
Tensile strength						
Parallel to grain (length 3 000 mm)	$f_{t,0,k}$	E	N/mm ²	36	18	18
Perpendicular to grain, edgewise	$f_{t,90,edge,k}$	F	N/mm ²	0.9	7	5
Compression strength						
Parallel to grain	$f_{c,0,k}$	G	N/mm ²	40	26	30
Perpendicular to grain, edgewise	$f_{c,90,edge,k}$	H	N/mm ²	7.5	9	9
Perpendicular to grain, flatwise	$f_{c,90,flat,k}$	I	N/mm ²	3.6	4	4
Shear strength						
Edgewise parallel to grain	$f_{v,0,edge,k}$	J	N/mm ²	4.6	4.6	4.6
Edgewise perpendicular to grain	$f_{v,90,edge,k}$	K	N/mm ²	NPD	4.6	4.6
Flatwise, parallel to grain	$f_{v,0,flat,k}$	L	N/mm ²	2.6	1.1	1.1
Flatwise, perpendicular to grain	$f_{v,90,flat,k}$	M	N/mm ²	NPD	1.1	1.1
Modulus of elasticity						
Parallel to grain	$E_{0,mean}$	A C	N/mm ²	14,000	10,000	10,600
Parallel to grain	$E_{0,k}$	A C	N/mm ²	12,000	9,000	9,000
Perpendicular to grain, edgewise	$E_{90,edge,mean}^1$	B	N/mm ²	430	3,500	3,000
Perpendicular to grain, edgewise	$E_{90,edge,k}^2$	B	N/mm ²	350	2,700	2,300
Perpendicular to grain, flatwise	$E_{m,90,flat,mean}$	D	N/mm ²	NPD	1,300	2,500
Perpendicular to grain, flatwise	$E_{m,90,flat,k}$	D	N/mm ²	NPD	1,000	1,800
Shear modulus						
Edgewise, parallel to grain	$G_{0,edge,mean}$	J	N/mm ²	600	600	600
Edgewise, parallel to grain	$G_{0,edge,k}$	J	N/mm ²	400	400	400
Flatwise, parallel to grain	$G_{0,flat,mean}$	L	N/mm ²	560	150	150
Flatwise, parallel to grain	$G_{0,flat,k}$	L	N/mm ²	400	130	130
Flatwise, perpendicular to grain	$G_{90,flat,mean}$	M	N/mm ²	NPD	150	150
Flatwise, perpendicular to grain	$G_{90,flat,k}$	M	N/mm ²	NPD	130	130
Density						
Mean value	ρ_{mean}	–	kg/m ³	550	530	530
Fifth percentile value	ρ_k	–	kg/m ³	480	480	480
Reaction to fire	–	–	–	D-s1, d0	D-s1, d0	D-s1, d0
Release of formaldehyde	–	–	–	E1	E1	E1
Natural durability against biological attack	–	–	–	4	4	4

Note: NPD – No Performance Determined

1) STEICO LVL R: $E_{c,90,edge,mean}$ | STEICO LVL X: $E_{m,90,edge,mean}$

2) STEICO LVL R: $E_{c,90,edge,k}$ | STEICO LVL X: $E_{m,90,edge,k}$

Mechanical properties of STEICO LVL

Explanation of the mechanical properties

The following table describes the relation between support, loading and labelling. The symbols refer to the table "Mechanical properties of STEICO LVL" on the previous page.

Bending strength f_m and elastic modulus E

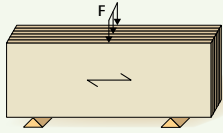

A $f_{m,0,edge}$ and $E_{0,edge}$
Edgewise, parallel to grain ♦

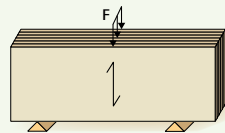

B $f_{m,90,edge}$ and $E_{90,edge}$
Edgewise, perp. to grain ♦♦

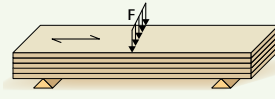

C $f_{m,0,flat}$ and $E_{0,flat}$
Flatwise, parallel to grain ♦

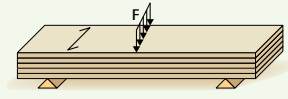

D $f_{m,90,flat}$ and $E_{90,flat}$
Flatwise, perp. to grain ♦♦

Tensile strength f_t

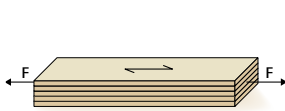

E $f_{t,0}$ parallel to grain ♦

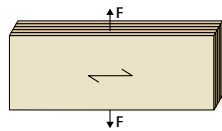

F $f_{t,90,edge}$
Edgewise, perp. to grain ♦♦

Compressive strength f_c

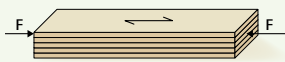

G $f_{c,0}$ parallel to grain ♦

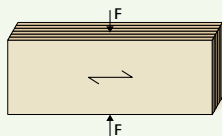

H $f_{c,90,edge}$
Edgewise, perp. to grain ♦♦

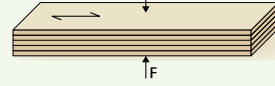

I $f_{c,90,flat}$
Flatwise, parallel to grain ♦♦

Shear strength f_v and modulus G

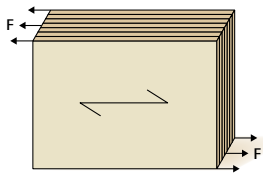

J $f_{v,0,edge}$ and $G_{0,edge}$
Edgewise, parallel to grain ♦

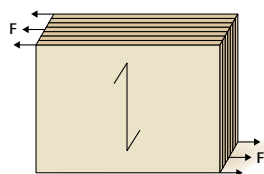

K $f_{v,90,edge}$
Edgewise, perp. to grain ♦♦

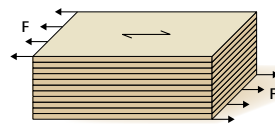

L $f_{v,0,flat}$ and $G_{0,flat}$
Flatwise, parallel to grain ♦

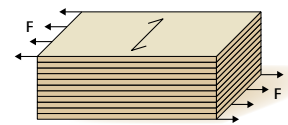

M $f_{v,90,flat}$ and $G_{90,flat}$
Flatwise, perp. to grain ♦♦

♦ parallel to the top veneer grain ♦♦ perpendicular to the top veneer grain

Calculation programs for STEICO *LVL* Laminated Veneer Lumber und STEICO*joist* I-Joists

For the structural calculation of building components the designer has numerous design programs available. The following details the various programs available with which both STEICO *LVL* Laminated veneer lumber and STEICO*joist* I-Joists can be calculated.

STEICO*xpress*



STEICO*xpress* is a free structural design program which allows simple and efficient design of STEICO *LVL* and STEICO*joist*. Regardless of whether single or multi span, floor or roof applications, the calculation of STEICO *LVL* and STEICO*joist* can be carried out in a few simple steps.

The calculation of service holes is also possible.

There are many other programs alongside STEICO*xpress* which are available. The following programs have both STEICO *LVL* and STEICO*joist* available in their databases.

Software solutions for calculation of STEICO *LVL* and STEICO*joist* I-joists

Software		STEICO <i>LVL</i>	STEICO <i>joist</i>	Further Information
STEICO <i>xpress</i>		✓	✓	www.steico.com
mb AEC Software GmbH		✓	-	www.mbaec.de
Frilo Software		✓	-	www.frilo.eu/de
Harzer Statik Software		✓ ¹	✓	www.harzerstatik.de
Dlupal Software		✓	✓	www.dlupal.com
SOFISTIK		✓ ¹	-	www.sofistik.de
VC Master		✓ ^{1, 2}	✓ ¹	www.vcmaster.com
PCAE		2	-	www.pcae.de

1) Manual input of material data required

2) Implementation of STEICO *LVL* into database in progress



BauStatik von mb AEC Software GmbH

STEICO *LVL* is available for the user of the mb Work Suite in following applications:

- S110.de/at Wood rafter
- S120.de/at Wood rafter plumb /square cut
- S130.de/at Wood purlin in roof pitch
- S172.de Wood mono pitch binder
- S201.de Wood concrete composite floor
- S202.de Wood vibration check
- S302.de/at Wood continuous, DIN EN 1995-1-1
- S322.de/at Wood continuous, double bending
- S400.de/at Wood column
- S410.de Wood column system, DINEN1995-1-1
- S602.de Wood calculation, framework
- S852.de/at Wood calculation, table values



Frilo Software

STEICO *LVL* is available for the user of the Frilo software in following applications:

- H01+ Wall stud (new)
- H011+ Timber calculation (new)
- DLT+ Continuous member (integration in planning)



Harzer Statik Software

STEICO*joist* I-joists can be calculated in the following modules:

- Floor joists
- Floor beams

In addition the user can freely define the material



RFEM und RSTAB von Dlupal

STEICO*joist* I-joists can be calculated in the following modules:

- RF-/LIMITS

STEICO *LVL* is available for the user of RFEM/ RSTAB software from Dlupal in the following modules:

- RF-/HOLZ Pro
- RF-/LIMITS

In addition the user can freely define the material.

Fasteners in STEICO LVL

Up to 37% higher hole bearing strength

For the connection design in STEICO LVL, the specification of the German technical approval AbZ Z-9.1-842 apply in combination with the requirements according to DIN EN 1995-1-1 for solid timber (STEICO LVL R) and plywood (STEICO LVL X). Accordingly, nails, screws, clamps, dowels, pins, split-rings and shear plates are allowed.

In contrast to conventional wood-based materials, dowel-type fasteners may also be installed in the edge face of STEICO LVL

- STEICO LVL consists of softwood and is easy to process
- Installation of nails, screws and clamps without drilling possible
- Due to the high material strength, fewer fasteners with smaller diameters and at larger spacings can be used
- Fasteners may also be installed in the edge face

The table summarizes the modification factors which apply for fasteners used in shear in STEICO LVL

	Fastener	STEICO LVL R	STEICO LVL X
Wide face	Nails, screws, clamps, not predrilled	137%	137%
	Nails, screws, clamps, predrilled	110%	110%
	Drift pins	110%	110%
Edge face	Nails, screws, clamps, not predrilled	96%	55%
	Nails, screws, clamps, predrilled	82%	41%
	Drift pins	82%	41%
End face	According to fastener product approval		

The table above is showing modification factors for shear in different applications and compares solid timber C24 to STEICO LVL. The modification factors for not pre-drilled fasteners refer to equation 8.15 of DIN EN 1995-1-1, and for pre-drilled fasteners to equation of 8.16.

If specific fastener product approvals include rules for the design in laminated veneer lumber, then these rules may be applied to STEICO LVL.

Spacing in STEICO LVL 1

The spacings (edge and end distances) are specified in the adjacent drawing as defined by DIN EN 1995-1-1. The minimum spacings can be taken either from DIN EN 1995-1-1 in conjunction with the national application document or from the specific fastener (e.g. screws) product approval.



Easy to work with
No pre-drilling
necessary

Nails, screws and clamps
can be inserted into

STEICO LVL without predrilling, thus fast
working progress

Definition of the faces

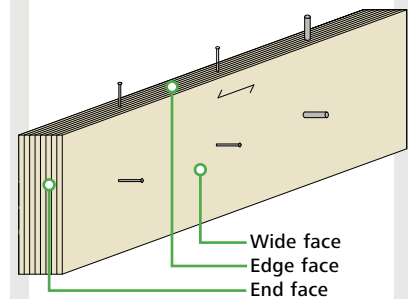

Spacing in STEICO LVL

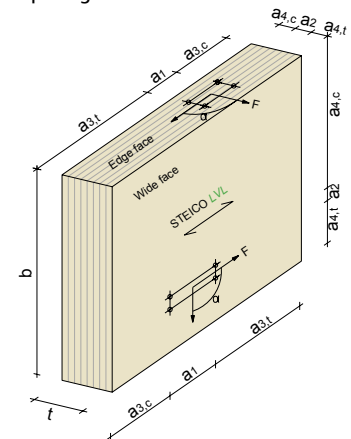

- a₁** Distance parallel to the grain
- a₂** Distance perp. to the grain
- a_{3,t}** Distance to loaded end
- a_{3,c}** Distance to unloaded end
- a_{4,t}** Distance to loaded edge
- a_{4,c}** Distance to unloaded edge
- α** Angle between force and grain direction

Further properties of STEICO *LVL*

Further properties of STEICO *LVL*

The following table summarizes physical and other technical data of STEICO *LVL R* and STEICO *LVL X*

Wood species	STEICO <i>LVL R</i>	Pine and/or spruce	FSC® certified (PEFC® on request)	
	STEICO <i>LVL X</i>	Pine and/or spruce	FSC® certified (PEFC® on request)	
Average wood moisture content	u = approx. 9%			
Service class	1 and 2			
Bonding of the veneer scarf joints on the board top surface	Melamine Adhesive		Clear glue joint, waterproof	
Bonding of the layers and all other scarf joints	Phenolic Adhesive		Dark glue joint, waterproof	
Release of formaldehyde	0.03 ppm			DIN EN 717-1 and according to QDF♦ – Guideline A 01
Surface quality	Non-vision quality		Structural product	
Thermal conductivity	$\lambda_R = 0.13$ W/mK			
Diffusion resistance, air tightness	$\mu_{wet} = 75$ $\mu_{dry} = 205$		Approved as airtight layer	According to DIN 4108-7 Table 6.1.3
Charring rate	$\beta_0 = 0.65$ mm/min		For panels	According to DIN EN 1995-1-2 Table 3.1
	$\beta_n = 0.70$ mm/min		For beams	
Tolerances	Length l	± 5 mm	For all lengths	According to DIN EN 14374:2005-02
	Width b	± 2 mm	b ≤ 400 mm	
		± 0.5 %	b > 400 mm	
Thickness t	+(0.8+0.03t) -(0.4+0.03t)	For all thicknesses		
Swelling and shrinkage	In % per 1% humidity change below the fiber saturation point			According to DIN EN 1995-1-1/NA Table NA.7
	STEICO <i>LVL R</i>	0.01	In veneer longitudinal direction (length)	
		0.32	In veneer cross direction (width/height)	
		0.32*	Perpendicular to the glue line (thickness)	
	STEICO <i>LVL X</i>	0.01	In veneer longitudinal direction (length)	* Internal producer tests
		0.03	In veneer cross direction (width/height)	
0.32*		Perpendicular to the glue line (thickness)		
Sound insulation	250 Hz to 500 Hz	$\alpha = 0.1$		According to DIN EN 13986 Table 10
	1000 Hz to 2000 Hz	$\alpha = 0.3$		
Natural durability against biological attack	4		Durability corresponding to the veneers	DIN EN 350-2
Waste disposal (AVV/EAK)	030105/170201		Disposal like wood and wood materials	

♦QDF = Quality consortium of German construction fabrication

Lay-up of STEICO *LVL*

The lay-ups of STEICO *LVL R* and STEICO *LVL X* are shown below. In STEICO *LVL R*, all veneers run parallel. However, in STEICO *LVL X*, 20% of the veneers are glued cross-wise in transverse direction to the other veneers.

Thickness [mm]	Number of veneer layers	STEICO <i>LVL R</i> Lay-up	STEICO <i>LVL X</i> Lay-up	STEICO <i>LVL X</i> number of cross-layers
21	7		I-III-I oder II-I-II	2
24	8		II-II-II	2
27	9		II-III-II	2
33	11		II-III-II	2
39	13		II-III-III-II	3
45	15		II-III-III-II	3
51	17		II-III-III-II	3
57	19		II-III-III-III-II	4
63	21		II-III-III-III-II	5
69	23		II-III-III-III-II	5

General Information STEICO LVL

Storage and transportation

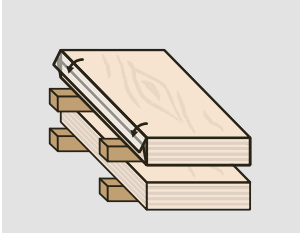

- STEICO LVL should be stored flat on bearers and on a dry load bearing surface.
- During Transport, Storage and through the building phase STEICO LVL should be protected from moisture (eg stored indoors or covered on site etc.)
- Where the possibility of rain splash back exists STEICO LVL should be stored a minimum of 30cm above ground level.
- As with softwood, moisture content levels may vary due to localised climate conditions.
- Care should be taken when walking on protective coverings and packaging due to the risk of slipping.
- Product should be securely stored once removed from original packaging and banding has been removed.
- Standard STEICO LVL packs can weigh up to 3 tonnes and therefore suitable lifting and transportation equipment should be used
- Damaged product should not be used.

Directions for use with moisture



- STEICO LVL can be used in Service Class 1, 2 & 3. In Service Class 3 chemical additives are required.
- STEICO LVL is one of the most dimensionally stable timber products. Moisture content direct from production is approx. 9% and therefore no shrinkage should be expected. However, if subjected to unregulated moisture exposure dimensional variations such as shrinkage or swelling can occur.
- Differentiations in moisture content within single STEICO LVL boards can lead to cupping.
- Large format, horizontally laid applications should utilise STEICO LVL X

- Standing water as well as long term exposure to direct weathering should be avoided. If exposed to direct weathering localised delamination of the veneers can occur where knots, fissures or scarf joints are present. The top surface of the veneer becomes rougher and unevenness and existing fissures become more apparent. The strength is not effected.
- Moisture contents in LVL should be established using an average result from an oven drying method (EN 322). Standard moisture meters, that measure moisture content via electrical resistance, will not get accurate results for STEICO LVL.

Machining and processing

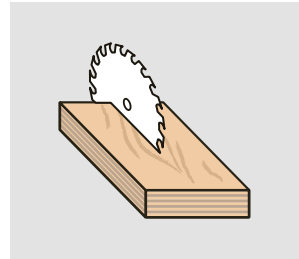

- For handling and cutting of STEICO LVL, as with softwood, please use standard wood working tools and machinery along with the appropriate PPE (Personal Protective Equipment).

Notes to the product surface



- Delivered product is unhanded and designed for use as a non-visual construction product.
- Exposure to light can lead to changes in colour as with standard timber products.
- With exposure to increased moisture content the formation of mold is possible as it is with standard softwood.
- For surface coatings the rules and regulations of the surface coating manufacturer should be followed (Sanding, easing of edges, coating thickness etc.).

Delivery formats of STEICO *LVL R* Laminated Veneer Lumber

Length [m]	Thickness [mm]	Width / Height [mm]	Nr. / package	Weight / package [t]	
				L = 9.00 m	L = 12.00 m
9.00 12.00	39	200	36	1.52*	2.03
		220	30	1.39*	1.86
		240	30	1.52	2.03
		300	24	1.52	2.03
		360	18	1.37*	1.82
		400	18	1.52	2.03
	45	200	36	1.75*	2.34
		220	30	1.61*	2.14
		240	30	1.75	2.34
		280	24	1.64*	2.18
		300	24	1.75	2.34
		360	18	1.58*	2.10
	75	200	18	1.75	2.34
		200	24	1.95*	2.60
		220	20	1.79*	2.38
		240	20	1.95	2.60
		280	16	1.82*	2.42
		300	16	1.95	2.60
		360	12	1.75*	2.34
		400	12	1.95	2.60

* Not in stock. Delivery on request.

Delivery formats of STEICO *LVL X* Laminated Veneer Lumber

Length [m]	Thickness [mm]	Width/Height [mm]	Nr. / package	Weight / package [t]	
				L = 6.00 m	L = 12.00 m
6.00 12.00	30	1,250	10	1.35	2.70
	33	1,250	8	1.19	2.38
	39	1,250	6	1.06	2.11
	57	1,250	4	1.03	2.06
	63	1,250	4	1.14	2.27

Delivery formats of STEICO *LVL X* rimboards

Length [m]	Thickness [mm]	Height [mm]	Nr. / package	Weight / package [t]	
				L = 6.00 m	L = 12.00 m
6.00 12.00	30	240	50	1.30	2.60
		260	40	1.13	2.25
	33	240	40	1.15	2.29
		260	32	0.99	1.98
	39	240	30	1.02	2.03
		260	24	0.88	1.76
	57	240	20	0.99	1.97
		260	16	0.86	1.71

Information on available formats for STEICO *LVL RL* wall studs is available in the current price list.

Special formats, special qualities and deliveries with special packaging units of STEICO *LVL* are available upon request (maximum 90 mm thick, 2.50 m width and length of 18.0 m); 6.0 m 14-16 packages/truck; 13.0 m 7-8 packages/truck

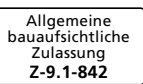

STEICO
engineered by nature

Your STEICO Dealer

www.steico.com

Certification

STEICO *LVL R* and STEICO *LVL X* Laminated Veneer Lumber are produced and quality-controlled according to the harmonized European product standard EN 14374, are CE certified and have German technical approvals. FSC®- (Forest Stewardship Council®) and PEFC®- certified products are available upon request.



High load carrying capacity, large spans



Very small tolerances



High dimensional stability

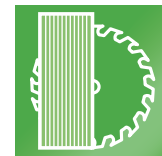

Easy to process

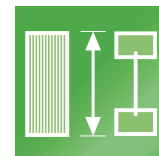

Adapted to STEICO I-joists

Storage / transport

STEICO *LVL* laminated veneer lumber must be stored flat and on a dry surface. STEICO *LVL* should be protected from dirt and moisture during transportation and storage.

International applicability

Please note: This is a courtesy translation of the German construction guide. Special national regulations may apply and have to be observed if necessary.